

SH-503

6 Jet Shower Head

Connection Type: 1/2" Female Supply

Flow Rate: 1.75 GPM

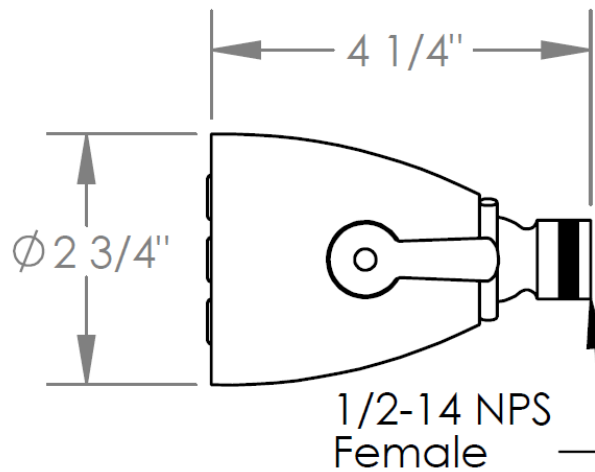
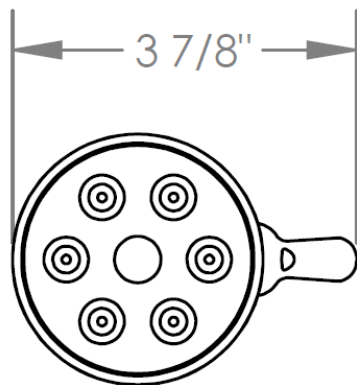

Meets the applicable requirements of ASME A112.18.1-2005/CSA B125.1-05, entitled "Plumbing Supply Fittings"

WATERMARK DESIGNS 9/5/2018

350 Dewitt Ave Brooklyn NY 11207 USA T 718 257 2800 F 718 257 2144 info@watermark-designs.com