

70-P90-RNK8

Pressure Balance Shower Trim

For use with SS-PB85 pressure balance valve

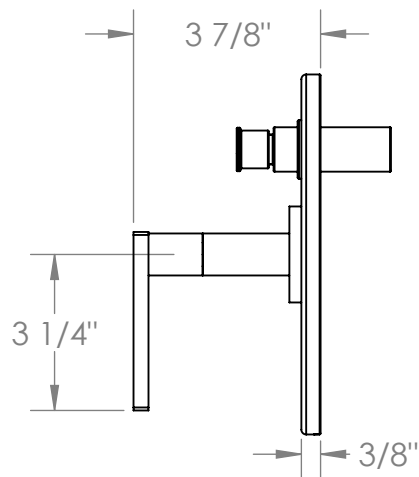
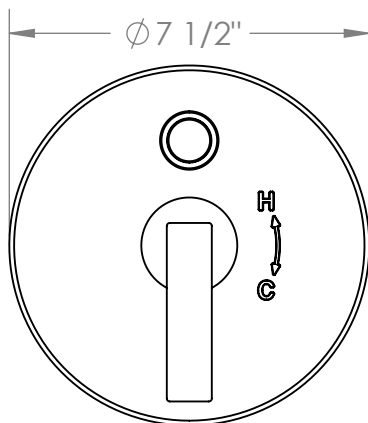

Meets the applicable requirements of ASME A112.18.1-2005/CSA B125.1-05, entitled "Plumbing Supply Fittings"