

25-HAF

Shower Head, Arm and Flange

Flow Rate: 2.0 GPM

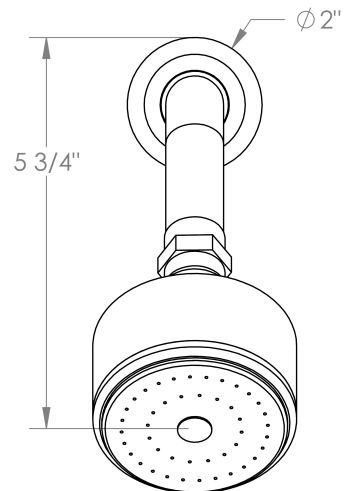
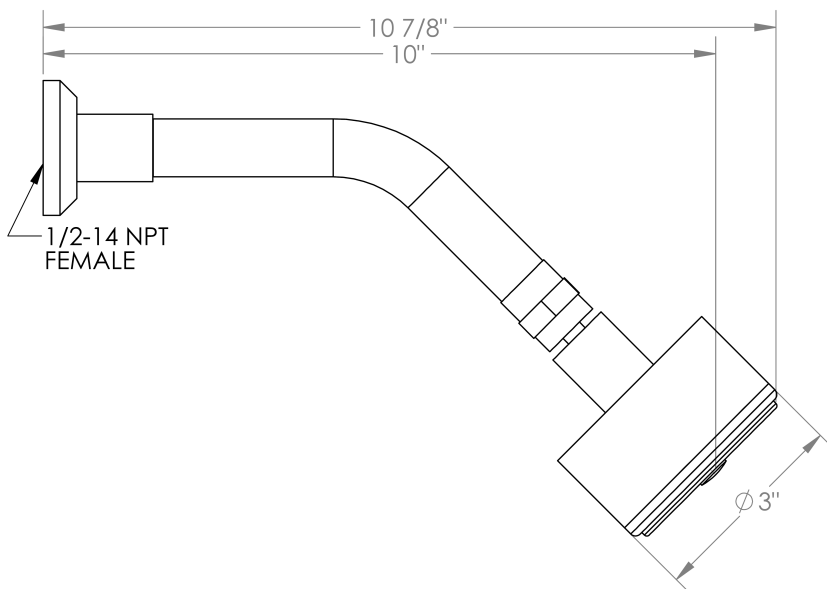

Meets the applicable requirements of ASME A112.18.1-2005/CSA B125.1-05, entitled "Plumbing Supply Fittings"