

**201-0.4**  
Paper Holder

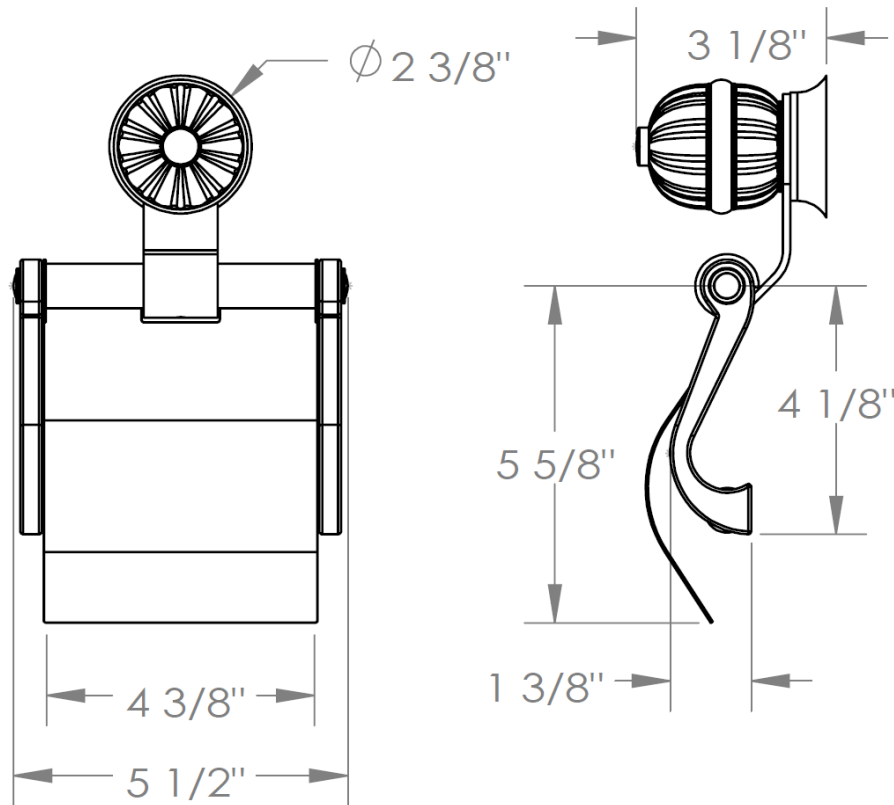

**WATERMARK DESIGNS 1/19/2015**