

8" ROUND INDUSTRIAL RAIN SHOWER HEAD

RS256-1

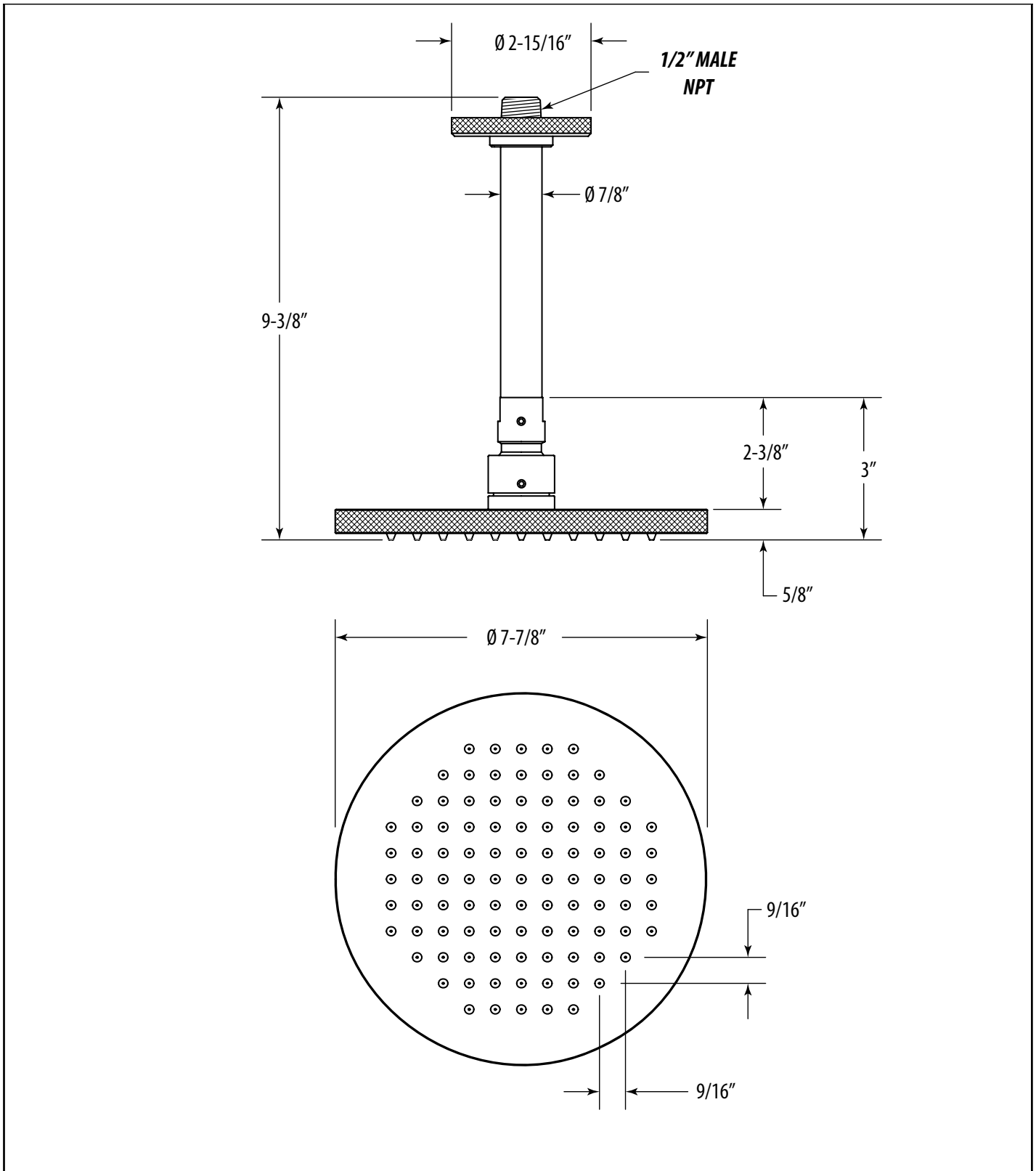

DIMENSIONS MAY VARY AND ARE SUBJECT TO CHANGE. NO RESPONSIBILITY IS ASSUMED FOR USE OF SUPERCEDED OR VOIDED DATA

