

TOWSON BRIDGE FAUCET / 18" ARTICULATED SPOUT / CROSS HANDLES

6150-18

- Max Counter Thickness 2-3/8"
- Minimum Install Hole Size 1-3/8"

- A. Supply Hoses - 20" Long with 3/8" Compression Fittings
- B. Side Spray Connection with 1/4" NPT Pipe Fitting

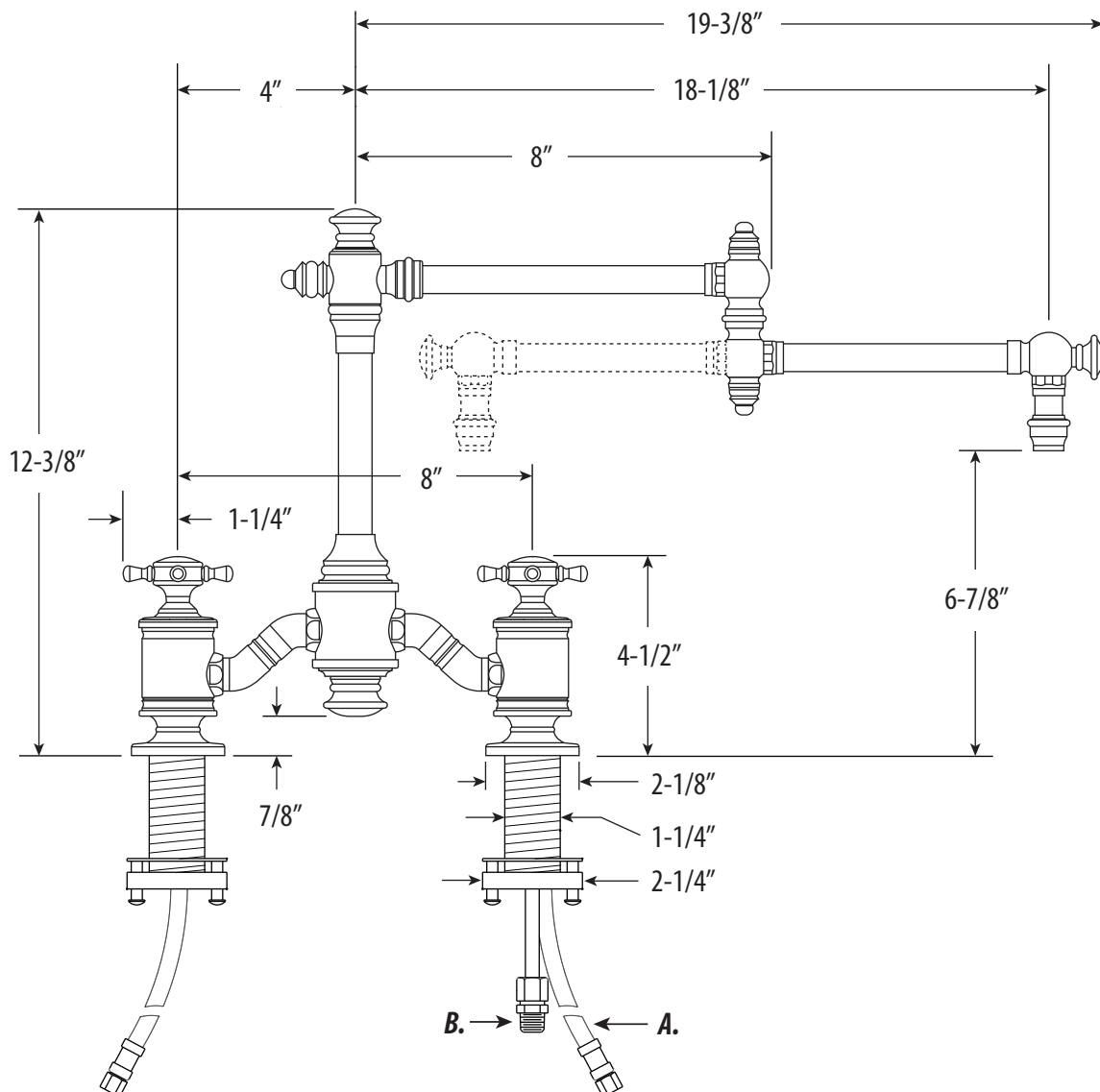

DIMENSIONS MAY VARY AND ARE SUBJECT TO CHANGE. NO RESPONSIBILITY IS ASSUMED FOR USE OF SUPERCEDED OR VOIDED DATA

TOWSON BRIDGE FAUCET / 18" ARTICULATED SPOUT / CROSS HANDLES

6150-18



Finish Shown - Satin Nickel

FEATURES

- Part of the traditional Towson Suite.
- Two-holed Bridge Faucet design mounts 8" on center.
- Articulated spout has 18" reach and can swivel 360 degrees.
- Equipped with spray diverter and 1/4" NPT pipe fitting connection for optional side spray.
- Ergonomic double cross handles.
- Hot and cold ceramic disk valve cartridges.
- 1.75 gpm maximum flow rate with aerated tip.
- Resistant to reverse osmosis water.
- Made from solid brass.
- Reinforced braided connection hoses.
- Includes 4 handle button options.
- Lifetime functional warranty.
- Made in the USA.

CODES/STANDARDS APPLICABLE

Specified model meets or exceeds the following:

- ASME A112.18.1
- CSA B125.1
- NSF 61, 372
- CALGreen



AVAILABLE IN 30 FINISHES