

TOWSON BRIDGE FAUCET / 18" ARTICULATED SPOUT / 4PC. SUITE

6150-18-4

- Max Counter Thickness 2-3/8"
- Minimum Install Hole Size 1-3/8"

- A. Supply Hoses - 20" Long with 3/8" Compression Fittings
- B. Side Spray Connection with 1/4" NPT Pipe Fitting

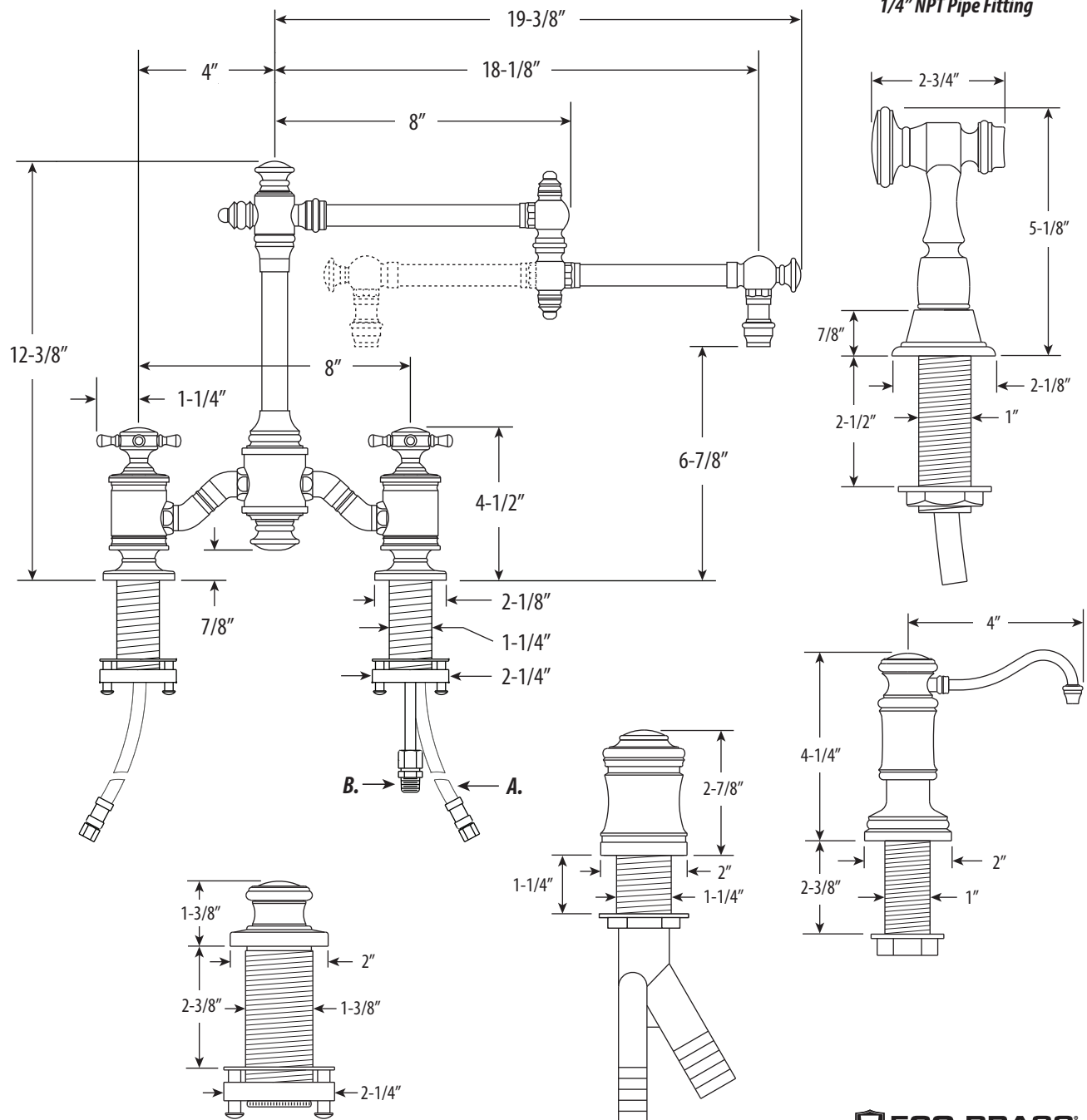

ECO BRASS
HIGH PERFORMANCE LEAD FREE BRASS

DIMENSIONS MAY VARY AND ARE SUBJECT TO CHANGE. NO RESPONSIBILITY IS ASSUMED FOR USE OF SUPERCEDED OR VOIDED DATA

TOWSON BRIDGE FAUCET / 18" ARTICULATED SPOUT / 4PC. SUITE

6150-18-4



Finish Shown - Satin Nickel

AVAILABLE IN 30 FINISHES

FEATURES

- Suite includes faucet, side spray, soap/lotion dispenser, air switch and single port air gap.
- Part of the traditional Towson Suite.
- Two-holed Bridge Faucet design mounts 8" on center.
- Articulated spout has 18" reach and can swivel 360 degrees.
- Equipped with spray diverter and 1/4" NPT pipe fitting connection for optional side spray.
- Ergonomic double cross handles.
- Hot and cold ceramic disk valve cartridges.
- 1.75 gpm maximum flow rate with aerated tip.
- Resistant to reverse osmosis water.
- Made from solid brass.
- Reinforced braided connection hoses.
- Includes 4 handle button options.
- Lifetime functional warranty.
- Made in the USA.

CODES/STANDARDS APPLICABLE

Specified model meets or exceeds the following:

- ASME A112.18.1
- CSA B125.1
- NSF 61, 372
- CALGreen

