

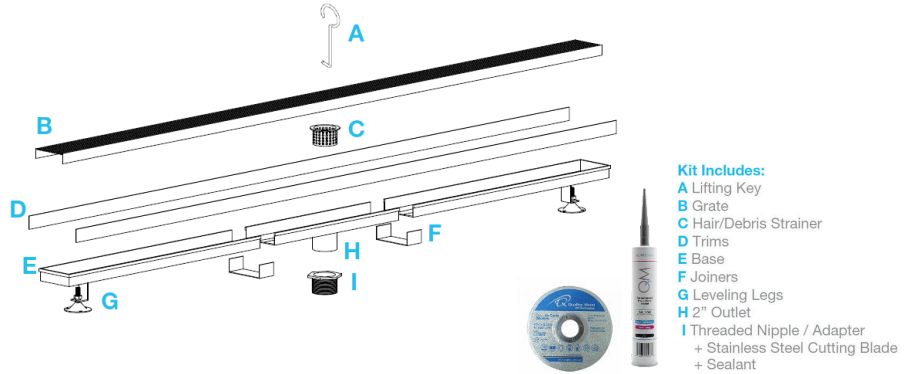

DelmarSeries ADJUSTABLE LINEAR DRAIN 2"

Adjustable Base | Traditional Waterproofing:

- Stainless Steel Gauges: Grates: 16 gauges
- Base: 18 gauges = 1.2 mm.
- Grate can be removed completely for cleaning.
- Adjustable is intended for use with traditional waterproofing methods.
- Works with 2" ABS, PVC or Cast Iron shower drain flange (not included).
- Hair strainer basket comes with every drain, fits inside the drain to collect hair and other debris, preventing clogged pipes.



Kit Includes:

- A Lifting Key
- B Grate
- C Hair/Debris Strainer
- D Trims
- E Base
- F Joiners
- G Leveling Legs
- H 2" Outlet
- I Threaded Nipple / Adapter + Stainless Steel Cutting Blade + Sealant

Specifications

B Grate - Top View



B Grate - Side View

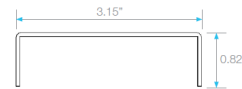

D Trims - Side View

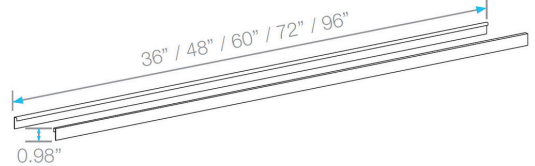

E Base - Side View



Top View

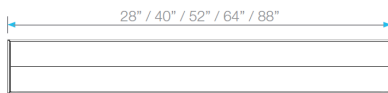

F Joiner - Side & Top View

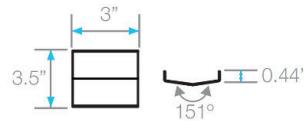

H 2" Outlet - Side & Top View

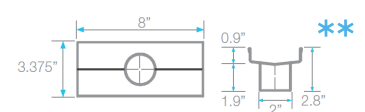

Base End Cap - Side View

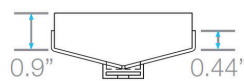

Corner - Top View

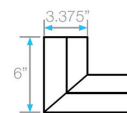

** 72" and *96" Kits include two outlets, two hair strainers, two pair of joiners and two adapters.

Complete Kits

PERFORATED



Satin	36"	33.620.36 ST	●
	48"	33.620.48 ST	●
	60"	33.620.60 ST	●
	72"	33.620.72 ST	●
	96"	33.620.96 ST	●
Polished	36"	33.620.36 PS	●
	48"	33.620.48 PS	●
	60"	33.620.60 PS	●
	72"	33.620.72 PS	●
	96"	33.620.96 PS	●