

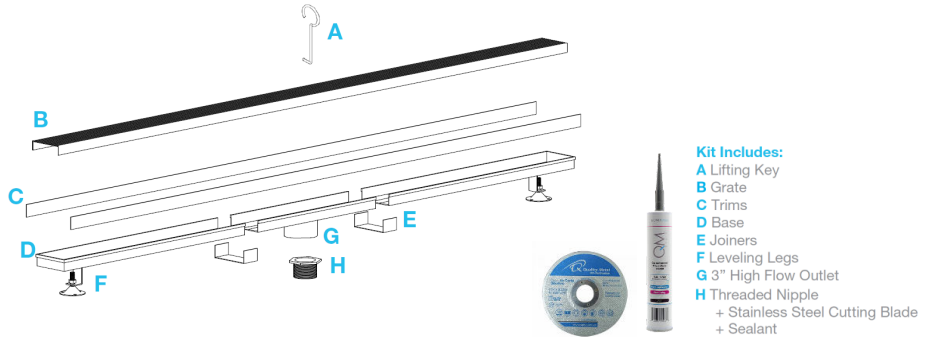

DelmarSeries ADJUSTABLE LINEAR DRAIN 3" HIGH FLOW OUTLET

Adjustable Base | Traditional Waterproofing:

- Stainless Steel Gauges: Grates: 16 gauges
- Base: 18 gauges = 1.2 mm.
- Grate can be removed completely for cleaning.
- Adjustable is intended for use with traditional waterproofing methods.



- Kit Includes:**
- A Lifting Key
 - B Grate
 - C Trims
 - D Base
 - E Joiners
 - F Leveling Legs
 - G 3" High Flow Outlet
 - H Threaded Nipple
- + Stainless Steel Cutting Blade
+ Sealant

Specifications

B Grate - Top View

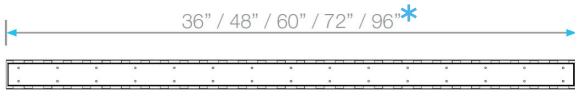

B Grate - Side View

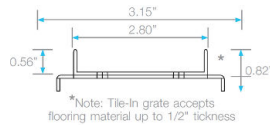

C Trims - Side View

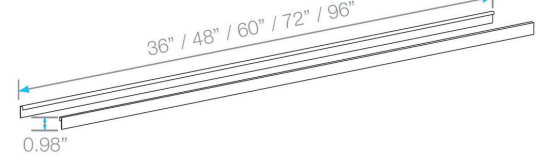

D Base - Side View



Top View

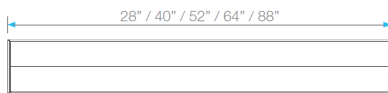

E Joiner - Side & Top View

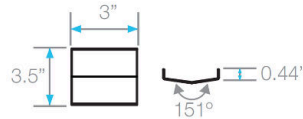

G 3" Outlet - Side & Top View

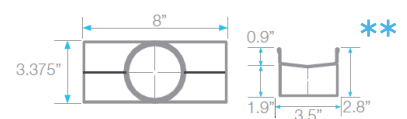

Base End Cap - Side View

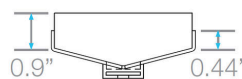

Corner - Top View

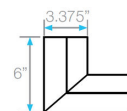

* 72" and 96" kits in black, gold and bronze have two 36" grates.

** 72" and *96" Kits include two outlets, two pair of joiners and two adapters.

Complete Kits

MIST (TILE-IN)



Bronze	36"	33.630.36HF BZ	●
	48"	33.630.48HF BZ	●
	60"	33.630.60HF BZ	●
	72"	33.630.72HF BZ	●
	96"	33.630.96HF BZ	●

Satin	36"	33.630.36HF ST	●
	48"	33.630.48HF ST	●
	60"	33.630.60HF ST	●
	72"	33.630.72HF ST	●
	96"	33.630.96HF ST	●

Polished	36"	33.630.36HF PS	●
	48"	33.630.48HF PS	●
	60"	33.630.60HF PS	●
	72"	33.630.72HF PS	●
	96"	33.630.96HF PS	●

Black	36"	33.630.36HF BK	●
	48"	33.630.48HF BK	●
	60"	33.630.60HF BK	●
	72"	33.630.72HF BK	●
	96"	33.630.96HF BK	●

Gold	36"	33.630.36HF GD	●
	48"	33.630.48HF GD	●
	60"	33.630.60HF GD	●
	72"	33.630.72HF GD	●
	96"	33.630.96HF GD	●