



ENGINEERING EXCELLENCE

Brentwood Series #3BR610

PARTS BREAKDOWN SHEET

DESCRIPTION

- Two Handle Lavatory Wall Mount Vessel Filler
- Porcelain Lever Handles
- 9-1/2" Reach
- Ceramic Disc Cartridges
- 3-Hole 8" Installation
- Includes Valve With Mounting Plate

FINISHES

- PC PVD Polished Chrome
- BN PVD Brushed Nickel
- PN PVD Polished Nickel
- PB PVD Polished Brass
- ORB Oil Rubbed Bronze



#3BR610 SHOWN * ADA 

STANDARDS APPLICABLE

- ASME A112.18.1
- ANSI A117.1
- ANSI / NSF 61, SECTION 9
- CUPC / IAPMO LISTED / ADA COMPLIANT
- CONTAINS NO MORE THAN 0.25% WEIGHTED AVERAGE LEAD CONTENT

FLOW

- Aerator Limited to 1.5 GPM

Model #: _____

Specific Features: _____

Project Name: _____

Submitted For: _____

NOTE :- There is more than 1 Versions of this Product. Page down to identify the version you have.

Model	Description	Finishes	
#3BR610	Two Handle Lavatory Wall Mount Vessel Filler	<input type="checkbox"/> PC	<input type="checkbox"/> Other ____



ENGINEERING EXCELLENCE

Pioneer:1-800-338-9468
 Commerce, CA 90040
 www.pioneerind.com
 Pioneer Industries, Inc. © 2013

DMPB3BR610/REV. 12 2012
 Page 1 of 3

	ITEM#	DESCRIPTION
A	X-1300010C,H*	Porcelain Lever Handle-Cold,Hot
B	X-4300030*	Valve Escutcheon
C	X-4300027*	Valve Sleeve
D	X-3300002C,H	Ceramic Disc Cartridge-Cold,Hot
E	X-4900054	Mounting Bracket With Screws
F	X-4900059	Valve mud guard
G	X-2300007*	Brentwood 9" Spout Set
1	X-4900042C,H*	Button-Cold,Hot
2	X-4300046	Handle Adapter
3	X-4900055	Mounting Screw
4	X-4900056	Mounting Screw & Washer
5	X-4900091*	1.5 GPM Aerator
6	X-4300031*	Spout Escutcheon

* Note- Please Specify finish\color code while ordering.

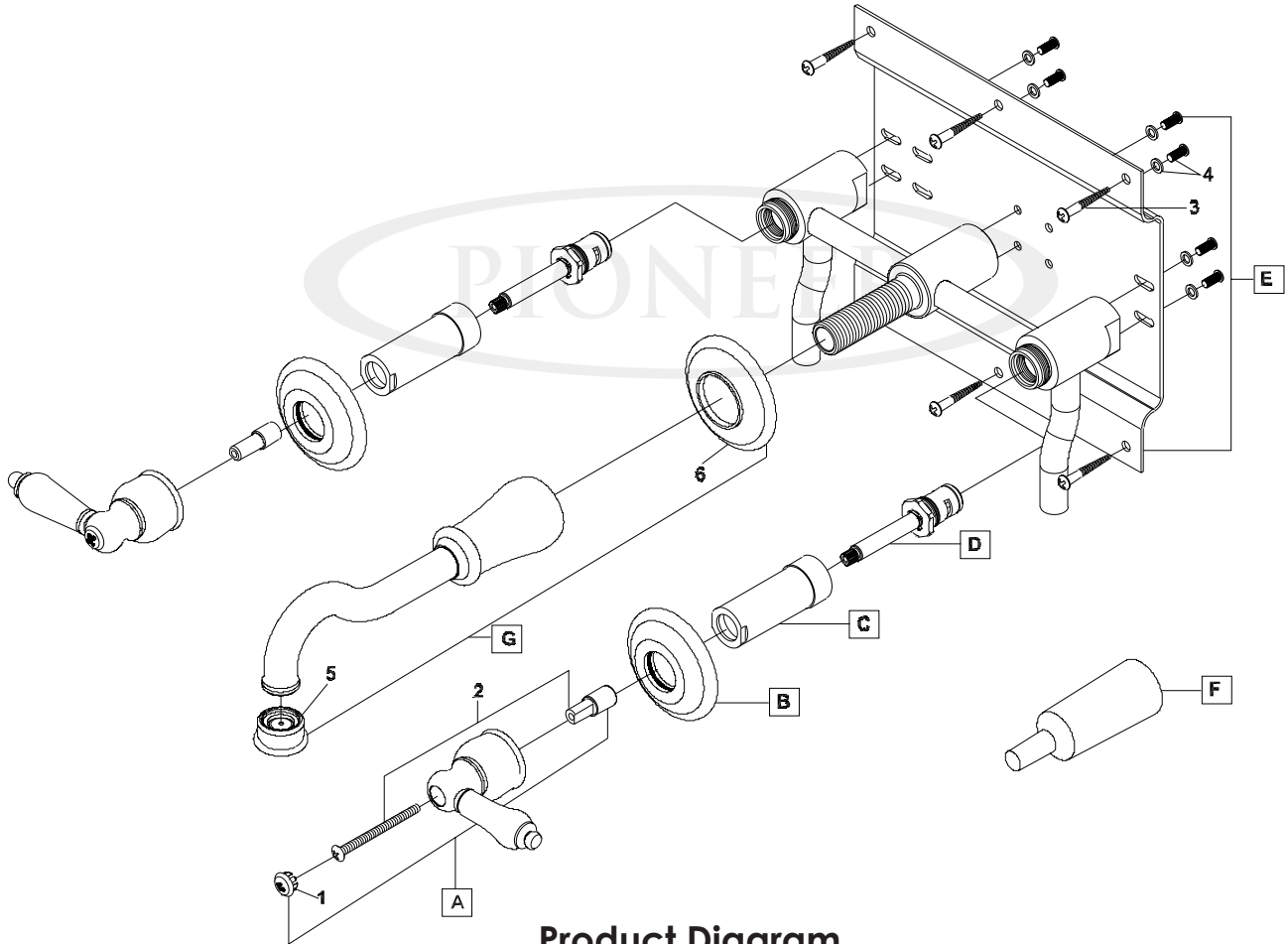

Product Diagram



ENGINEERING EXCELLENCE

Pioneer:1-800-338-9468
 Commerce, CA 90040
 www.pioneerind.com
 Pioneer Industries, Inc. © 2013

	ITEM#	DESCRIPTION
A	X-1900010C,H*	Porcelain Lever Handle-Cold,Hot
B	X-4300030*	Valve Escutcheon
C	X-4300027*	Valve Sleeve
D	X-3300005C,H	Ceramic Disc Cartridge-Cold,Hot
E	X-4900054	Mounting Bracket With Screws
F	X-4900059	Valve mud guard
G	X-2300007*	Brentwood 9" Spout Set
1	X-4900042C,H*	Button-Cold,Hot
2	X-4900061	Handle Screw
3	X-4900055	Mounting Screw
4	X-4900056	Mounting Screw & Washer
5	X-4900091*	1.5 GPM Aerator
6	X-4300031*	Spout Escutcheon

* Note- Please Specify finish\color code while ordering.

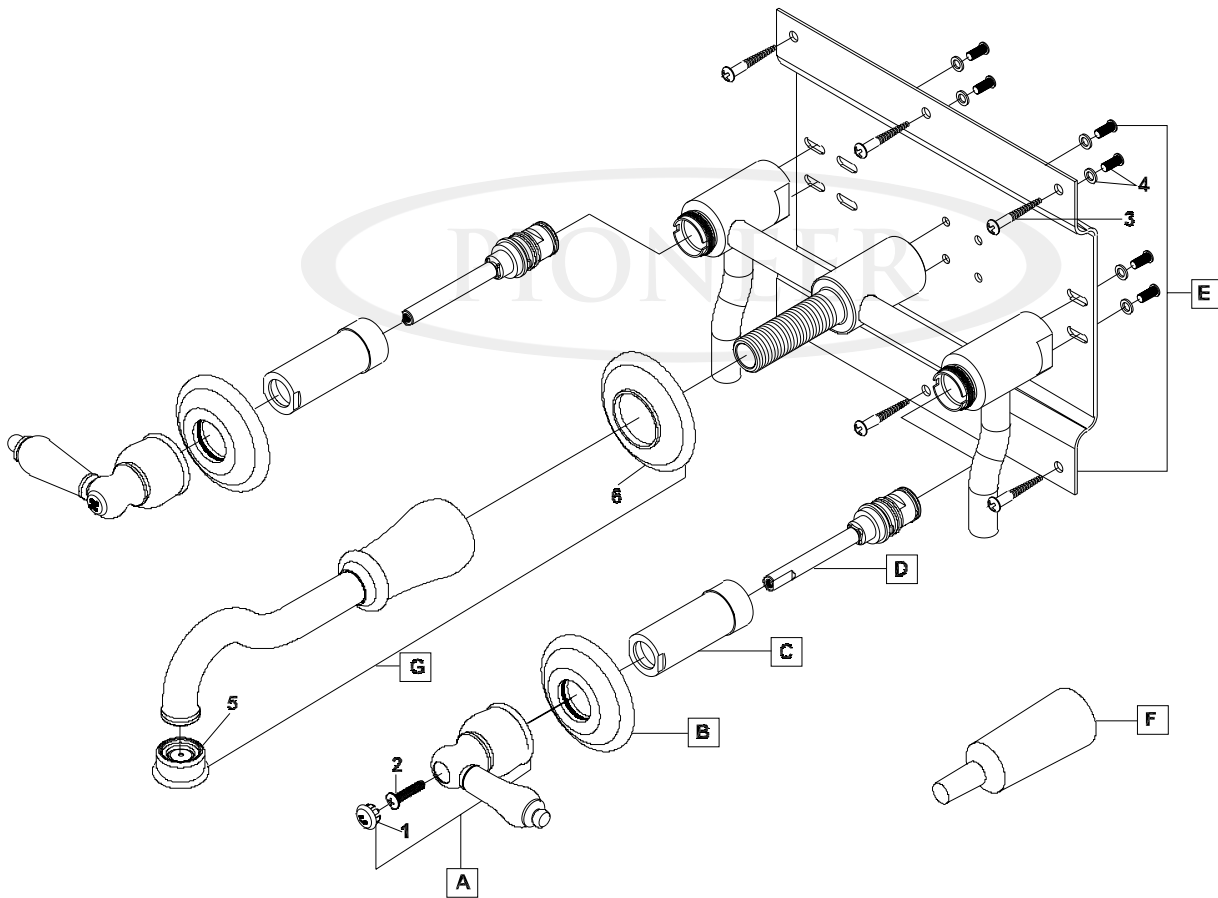

Product Diagram



ENGINEERING EXCELLENCE

Pioneer:1-800-338-9468
 Commerce, CA 90040
 www.pioneerind.com
 Pioneer Industries, Inc. © 2013