



ENGINEERING EXCELLENCE

Installation Guide

Two Handle Roman Tub Trim Set:

- 4PR610T

This product meets the following standards:

- ASME A112.18.1
- ANSI A117.1
- CUPC / IAPMO LISTED / ADA COMPLIANT

Thank you for purchasing this pioneer quality product.

Tools Required

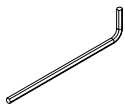
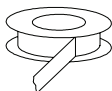

Teflon Tape

3/32" Allen
Wrench

Prior to Installation

- Observe all local plumbing and building codes before you begin installation.
- Carefully shut off both hot and cold main water supplies.
- Roman Tub Valve (4300B) must be installed prior to installing this trim.
- Pioneer reserves the right to make changes in the design of faucets without notice as specified in the pricebook.

Trim Installation

- Confirm the test plug (A) is threaded to the spout shank (B).
- Ensure the hot side valve and cold side valve are in fully closed position.
- Turn on the main water supply.
- Check for any leaks when the hot side and cold side valves are in closed and open position. Repair the leak if necessary.
- Close both side valves.
- Carefully remove the test plug turn on both side valves to drain any water then close both side valves.
- Reinstall the test plug to the spout shank and place the mudguards until trim is installed.

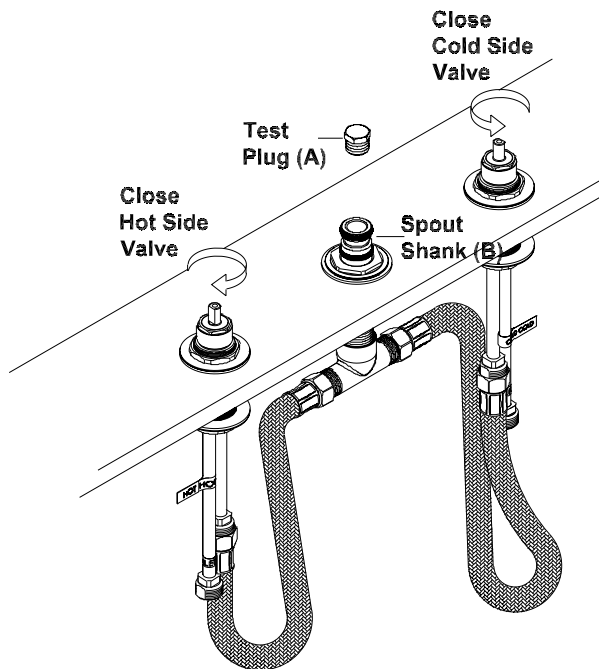

Trim Installation

- Remove the mudguards from the spout shank and valves.
- Confirm the valve and spout height from the finished deck or rim(C) is 1-3/4" and 1-3/8" respectively.
- Make necessary adjustment if necessary.
- Carefully remove the test plug (A) from the spout shank (B)

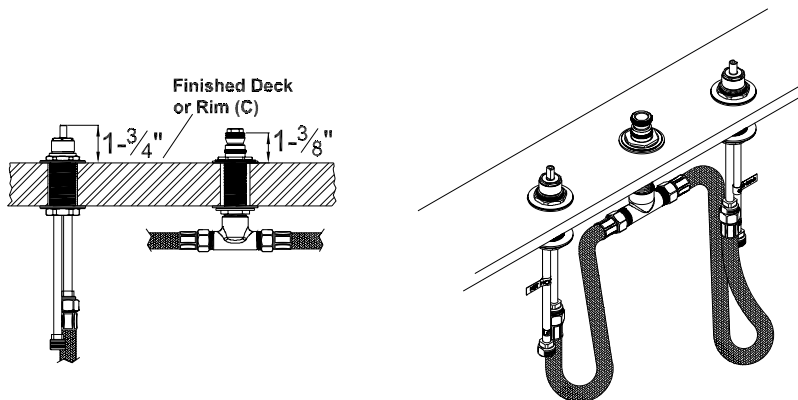

Trim Installation

1. Spout Installation: Place the gasket(G) underneath of the spout(D). Carefully slide the spout (D) on the spout shank (B) so the O-ring on the spout shank does not get damaged. Tighten the allen screw(E) with the help of the Allen wrench tool provided. Do not overtighten. Place the hole cover(F) to cover the hole.
2. Thread the handle locknut (K) as far it threads on the valve.
3. Install the stem extension(J) on the valve.
4. Place the Escutcheon(I) and install the handle(H) on handle locknut(K) with the help of handle tool(L). Install the other side handle and es-cutcheon. Ensure the handles moves in correct direction. Turn on both side handles. Check for any leaks.

Trim Installation

1

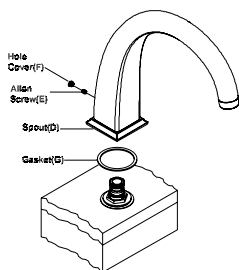

2

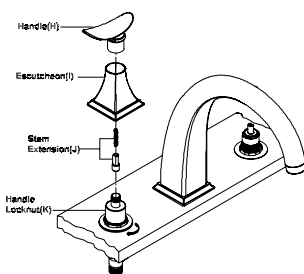

3

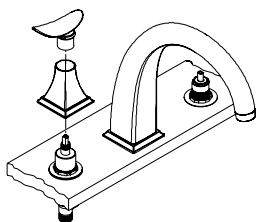

4

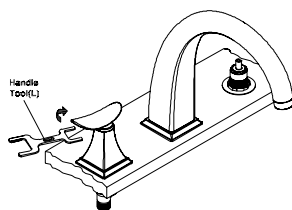

For more care information or trouble shooting inquiries about your Pioneer Product, please see the contact information on the back page.



ENGINEERING EXCELLENCE

3325 S. Garfield Ave. | Commerce, CA 90040
Telephone: (800) 338-9468 | (323) 888-8873 | Fax: (323) 888-9515
Hours: M - F, 7:30am to 5:00pm PST
www.pioneerind.com