



ENGINEERING EXCELLENCE

Motegi Series #3MT170

PARTS BREAKDOWN SHEET

DESCRIPTION

- Single Handle Lavatory Faucet
- Metal Lever Handle
- Straight Spout
- 3-3/4" Reach, 2-7/8" from Deck to Aerator
- Ceramic Disc Cartridge with Temperature Limit Stop
- 1-Hole Installation
- Brass Pop-Up Drain Assembly

FINISHES

- PC PVD Polished Chrome
- BN PVD Brushed Nickel
- SS PVD Stainless Steel
- PN PVD Polished Nickel
- PB PVD Polished Brass
- ORB Oil Rubbed Bronze



#3MT170 SHOWN * ADA 

STANDARDS APPLICABLE

- ASME A112.18.1
- ANSI A117.1
- ANSI / NSF 61, SECTION 9
- CUPC / IAPMO LISTED / ADA COMPLIANT
- CONTAINS NO MORE THAN 0.25% WEIGHTED AVERAGE LEAD CONTENT

FLOW

- Aerator Limited to 1.5 GPM



Model #: _____

Specific Features: _____

Project Name: _____

Submitted For: _____

Model	Description	Finishes	
#3MT170	Single Handle Lavatory Faucet	<input type="checkbox"/> PC	<input type="checkbox"/> Other__
#3MT171	Single Handle Lavatory Faucet-Less Pop-up	<input type="checkbox"/> PC	<input type="checkbox"/> Other__
#3MT171G	Single Handle Lavatory Faucet-With Grid Drain Assembly	<input type="checkbox"/> PC	<input type="checkbox"/> Other__



ENGINEERING EXCELLENCE

Pioneer:1-800-338-9468
 Commerce, CA 90040
 www.pioneerind.com
 Pioneer Industries, Inc. © 2013

DMPB3MT170/REV. 12 2012

Page 1 of 2

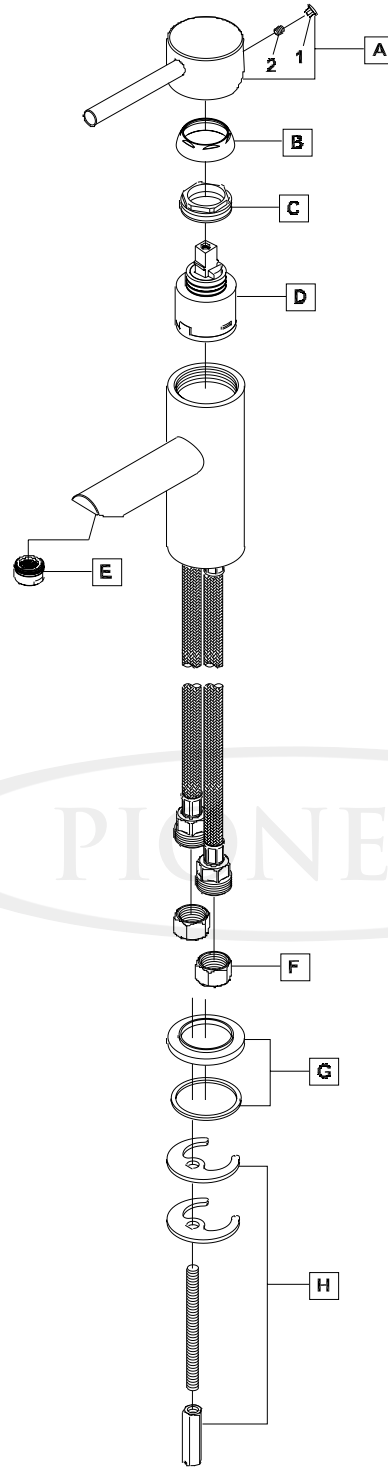

	ITEM#	DESCRIPTION
A	X-1900008*	Motegi Lever Handle
B	X-4900017*	Retainer Sleeve
C	X-4900018	Retainer Nut
D	X-3900001	Ceramic Disc Cartridge
E	X-4900089*	1.5 GPM Aerator
F	X-4900004	Supply Nut
G	X-4300019*	Escutcheon
H	X-5300012	Mounting Kit
I	X-6300006*	Brass Pop-Up Drain (For 3MT170)
I	X-6300002*	Brass Grid Drain (For 3MT171G)
1	X-4900044*	Hole Cover
2	X-4900024	3/32" Allen Screw

* Note: Please specify finish/color when ordering.

Product Diagram



ENGINEERING EXCELLENCE

Pioneer: 1-800-338-9468
 Commerce, CA 90040
 www.pioneerind.com
 Pioneer Industries, Inc. © 2013