



ENGINEERING EXCELLENCE

Installation Guide

Two Handle Kitchen Faucet:

- 2DM200
- 2DM201

This product meets the following standards:

- ASME A112.18.1
- ANSI A117.1
- ANSI / NSF 61, SECTION 9
- CUPC / IAPMO LISTED / ADA COMPLIANT
- CONTAINS NO MORE THAN 0.25% WEIGHTED AVERAGE LEAD CONTENT

Thank you for purchasing this Pioneer quality product.

Tools Required



Plumbers Putty

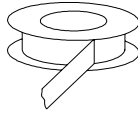

Sealant Tape

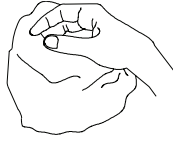

Rags

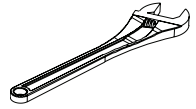

Adjustable-
Wrench

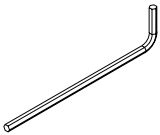

3/32" Allen
Wrench

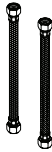

Flex Hose

Prior to Installation

- Observe all local plumbing and building codes before you begin installation.
- Carefully shut off both hot and cold water supplies from under the sink.
- Plug the sink drain with a soft cloth to prevent intrusion of debris or the loss of any faucet parts.
- For replacement installations, carefully remove the existing faucet and clean the entire surface of the sink mounting holes.
- Pioneer reserves the right to make changes in the design of faucets without notice as specified in the pricebook.

Faucet Installation

- **Note:** The faucet escutcheon (F) is supplied with gasket (G) to form watertight seal. Do not use gasket (G) and plumbers putty both to form watertight seal.
1. For the faucet with side spray, place the hose guide (A) through the sink hole. Apply adequate amount of plumbers putty or sealant along the boundary of the side spray flange (B).
 2. Hand tighten the locknut (C) from underneath the sink. Remove excess plumbers putty or sealant from the side spray flange (B).
 3. Insert the side spray and hose (D) through the hose guide (A).
 4. Insert gasket (G) into escutcheon (F) and slide escutcheon (F) onto spout shank.
 5. Insert the spout (E) through mounting surface.
 6. Slide the mounting bracket (H) through the spout shank. Thread and tighten the spout mounting Nut (I). Do not overtighten.
 7. Thread and tighten the "cross" or "Y" connector (J) to the spout. Do not overtighten.

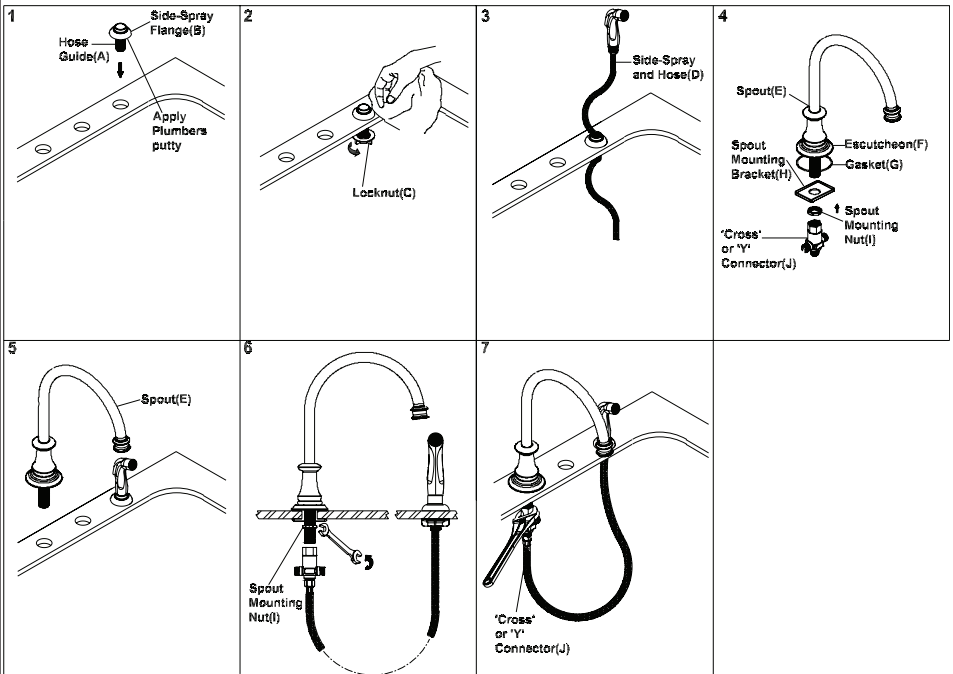

Faucet Installation

- **Note:** The faucet escutcheon (L) is supplied with gasket (M) to form watertight seal. Do not use gasket (M) and plumbers putty both to form watertight seal.
8. Place the escutcheon (L) from the top. Ensure the gasket (M) is beneath the escutcheon (L). The hot side valve should have red mark and the cold side should not have any mark. Place the cold side valve with washers (N & O) and locknut (P) from under the sink. Thread the escutcheon (L) on the valve. Adjust the valve to proper height. Install the handle (K) on the valve. Ensure the handle (K) moves in correct direction and it is secure on the valve.
 9. Make sure the valve outlet faces toward the spout. Install the hot side valve, handle and escutcheon same as cold side valve.
 10. Ensure the handles turn in correct direction. Confirm the valve outlet faces toward the spout (E). Tighten the locknut (P) to secure the valve to the mounting surface.
 11. Connect the hose from the "Cross" or "Y" connector (J) to the valve. Connect side spray hose for faucet with side spray to the "Cross" or "Y" connector (J).

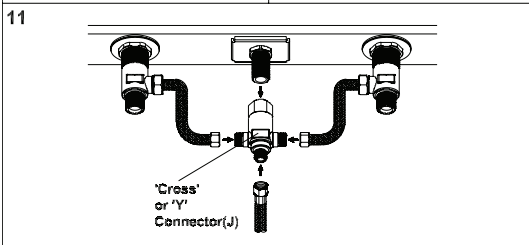
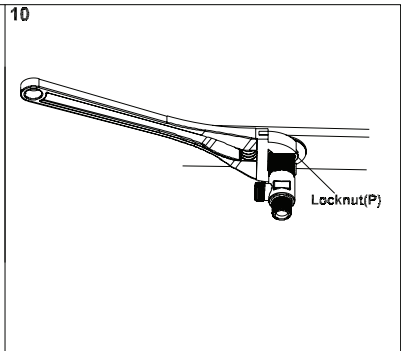
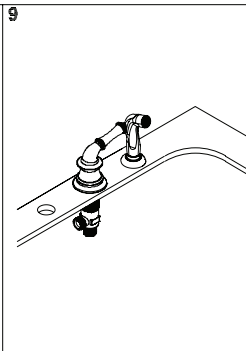
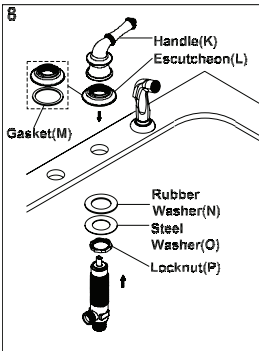

Main Supply Connection

12. Connect the valves to inlet supply lines (R). Connect the supply stops (Q) to the inlet supply lines (R) (left is hot water supply and right is cold water supply). Make sure inlet supply lines (R) are securely tighten. Do not overtighten. Turn on water.
13. Remove aerator (S).
14. Open the handles.
15. Check for any leaks. Make sure all the connection are secure.
16. Flush and allow water to run at full flow for at least one minute.
17. Close the handles.
18. Replace aerator (S).

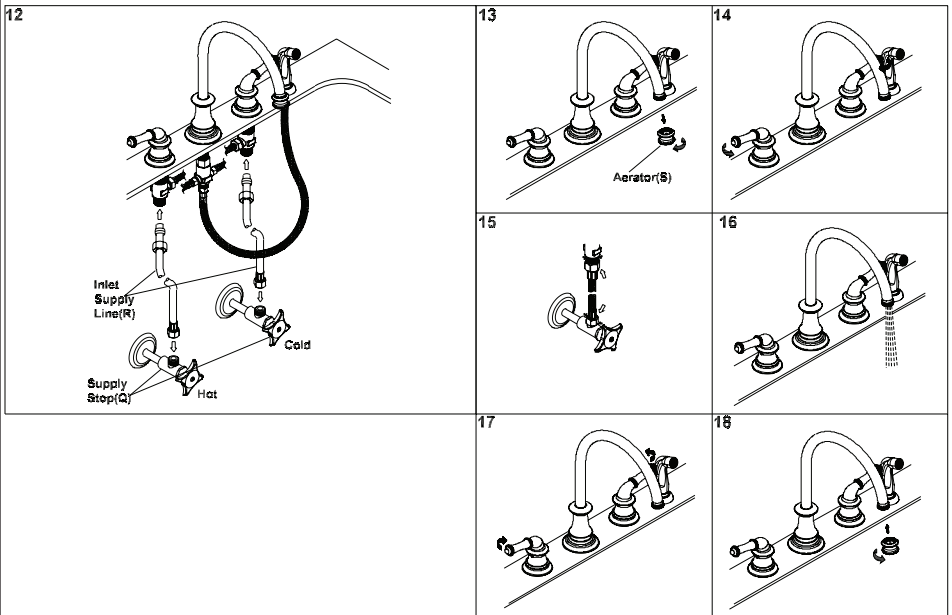

For more care information or trouble shooting inquiries about your Pioneer product, please see the contact information on the back page.



ENGINEERING EXCELLENCE

3325 S. Garfield Ave | City of Commerce, CA 90040
Telephone: (800) 338-9468 | (323) 888-8873 | Fax: (323) 888-9515
Hours: M - F, 7:30am to 5:00pm PST