

# FLUSH-MOUNT BRACKET KIT MTK-601AL

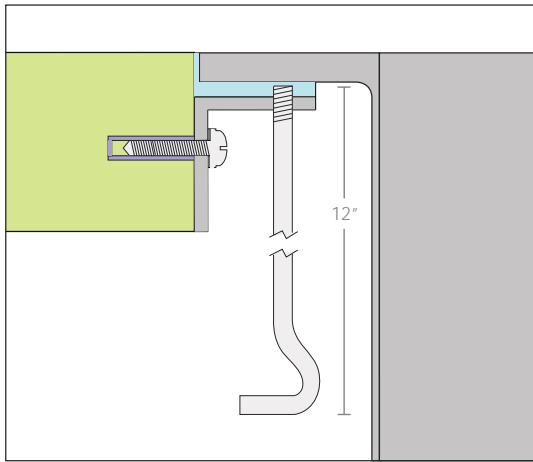

## DESCRIPTION

Flush-mount Installation Kit

## TECHNICAL INFORMATION

16 GA. 304 Stainless Steel Angle  
Stainless Steel 12" Height Adjusting Screw  
Stainless Steel Lock Washers  
Aluminum Anchors

## INCLUDED PARTS

#8-32 Screw  
12" Height Adjusting Screw  
#8 Lock Washer  
#8-32 Standoff

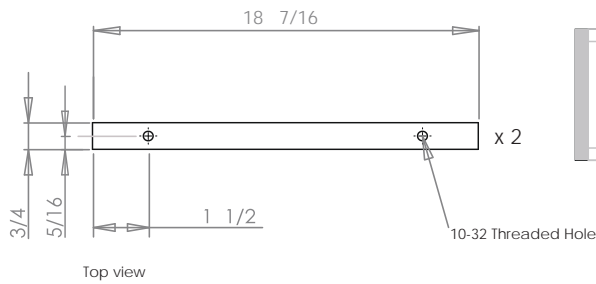
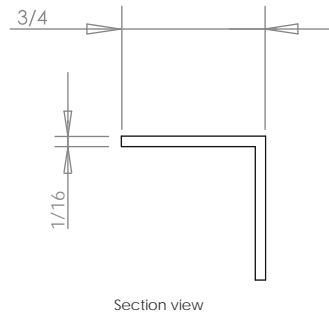
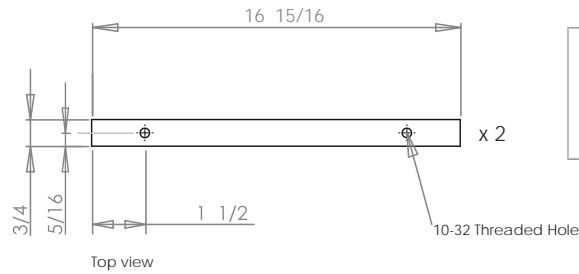
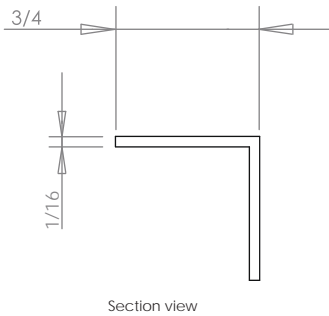
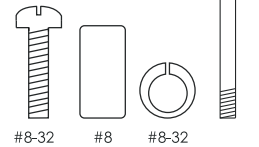

PROJECT INFORMATION			
Project			
Date	/ /	QTY	
Specifier			
Contact			
Note			