

# FLUSH-MOUNT BRACKET KIT MTK-105AL

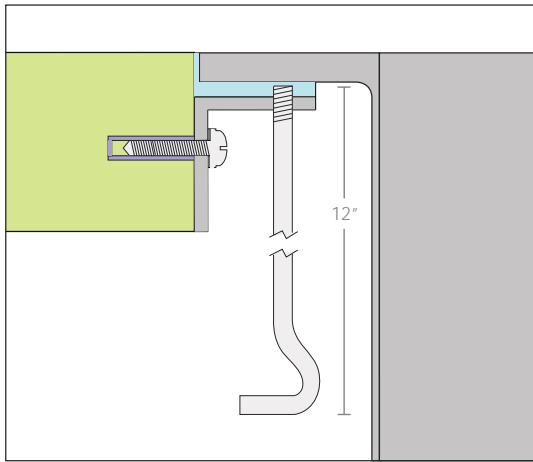

## DESCRIPTION

Flush-mount Installation Kit

## TECHNICAL INFORMATION

16 GA. 304 Stainless Steel Angle  
 Stainless Steel 12" Height Adjusting Screw  
 Stainless Steel Lock Washers  
 Aluminum Anchors

## INCLUDED PARTS

#8-32 Screw  
 12" Height Adjusting Screw  
 #8 Lock Washer  
 #8-32 Standoff

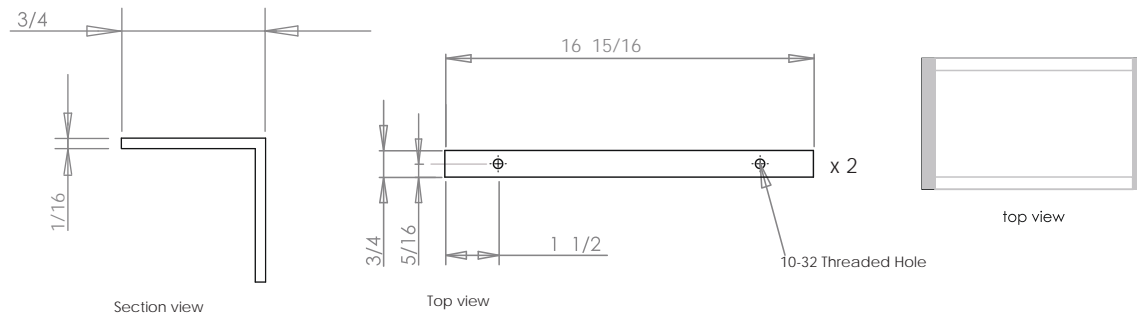
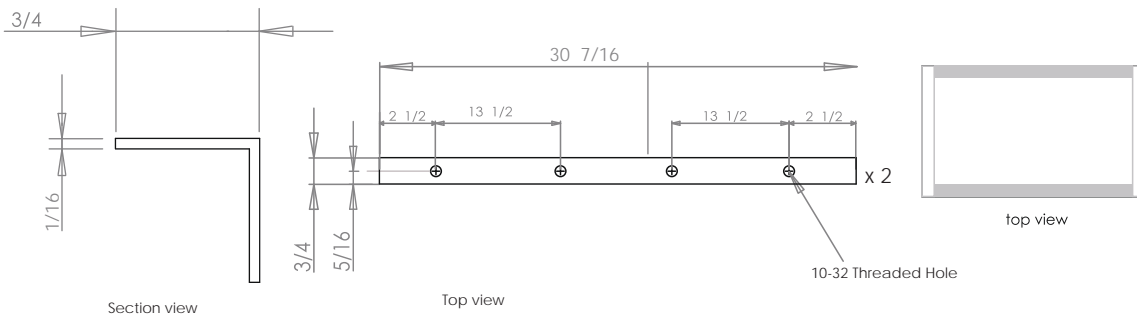
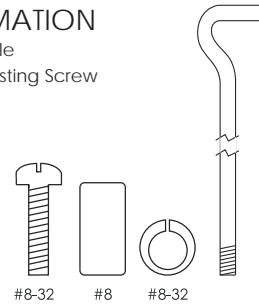

PROJECT INFORMATION			
Project			
Date	/ /	QTY	
Specifier			
Contact			
Note			