

# WORKSTATION MUWS-637GDSB

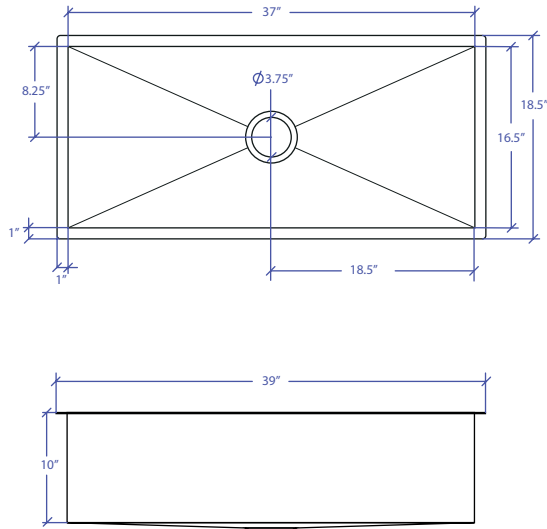

INDUSTRY'S ONLY STAINLESS STEEL SINK DESIGNED SPECIFICALLY TO BE FLUSH-MOUNTED



## • FEATURES

- 16-gauge type 304 stainless steel
- 5-gauge 304 stainless steel rim

## • TECHNICAL INFORMATION

- External dimension: 39" Lx18.5" Wx10" D
- Basin dimensions: 37" Lx16.5" Wx10" D
- Rim width: 1"
- Rim thickness: 1/4"
- Rim Corner: 1/4" round

## • FINISHES

- Gold PVD Satin Brushed stainless steel

## • INSTALLATION OPTIONS

- Under-mount

## • MINIMUM CABINET SIZE (I.D.)

- Under-mount 41"

## • INSTALLATION TYPE

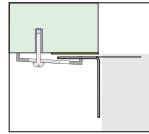

Under-mount

## • INCLUDED ACCESSORIES

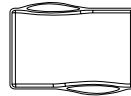

MWCB-651GDBB  
Cutting Board

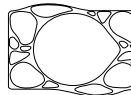

MWSM-651GDSB  
Salad Mixer

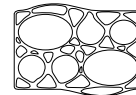

MWBM-651GDSB  
Bain Marie

## • OPTIONAL ACCESSORIES



MBG-6519GDSB  
Basin Grid



MWC-651GDSB  
Colander



MWSS-651GDSB  
Side Sink

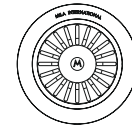

MKD-101GDSB  
Strainer

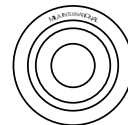

MDC-101GDSB  
Disposal Collar

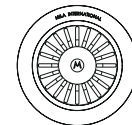

MDC-102GDSB  
Disposal Collar

US Patent No. 9,988,799 CA Patent No. 2579506  
International Patent Pending

PROJECT INFORMATION			
Project			
Date	/ /	QTY	
Specifier			
Contact			
Note			