

FLATIRON MUS-504SB

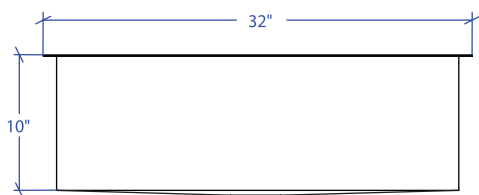

*Custom ADA compliant versions are available

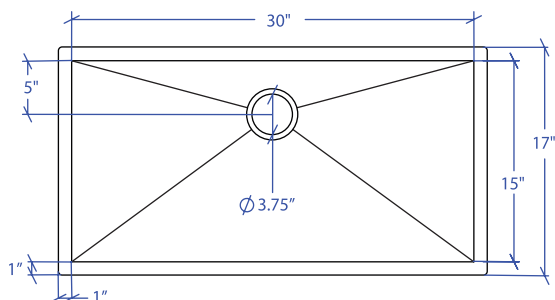

- **FEATURES**
16-gauge type 304 stainless steel
90° zero radius design
- **TECHNICAL INFORMATION**
External dimension: 32"Lx17"Wx10"D
Basin dimensions: 30"Lx15"Wx10"D
- **FINISHES**
Satin Brushed stainless steel
- **INSTALLATION OPTIONS**
Under-mount
- **MINIMUM CABINET SIZE (I.D.)**
Under-mount 35"

• DUAL-MOUNT INSTALLATION

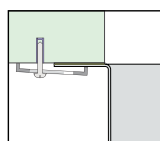

Under-mount

• ACCESSORY OPTIONS

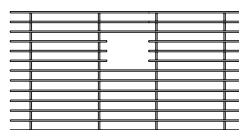

MBG-056SB
Basin Grid

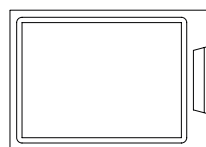

MCB-501BB
Cutting Board

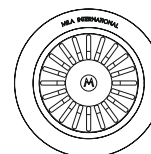

MKD-101SB
Strainer

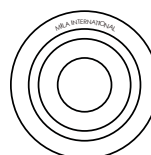

MDC-101SB
Disposal Collar

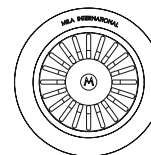

MDC-102SB
Disposal Collar

PROJECT INFORMATION			
Project			
Date	/ /	QTY	
Specifier			
Contact			
Note			

UNDER-MOUNT