

# FLATIRON MUD-652SB

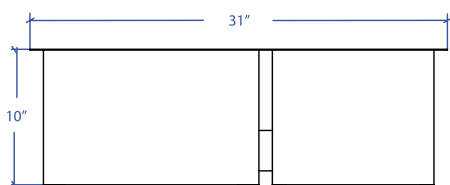

\*Custom ADA compliant versions are available

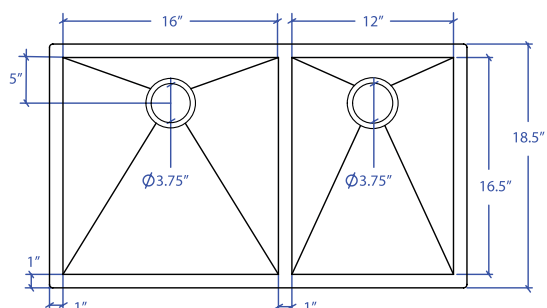

## • FEATURES

16-gauge type 304 stainless steel  
90° zero radius design

## • TECHNICAL INFORMATION

External dimension: 31"Lx18.5"Wx10"D  
Basin dimensions:  
Left: 16"Lx16.5"Wx10"D  
Right: 12"Lx16.5"Wx10"D

## • FINISHES

Satin Brushed stainless steel

## • INSTALLATION OPTIONS

Under-mount

## • MINIMUM CABINET SIZE (I.D.)

Under-mount 34"

## • DUAL-MOUNT INSTALLATION

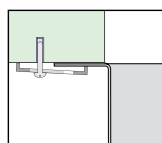

Under-mount

## • ACCESSORY OPTIONS

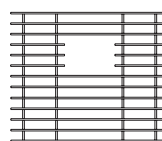

MBG-6504SB  
Basin Grid

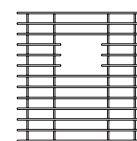

MBG-6501SB  
Basin Grid

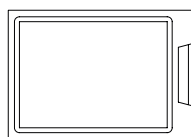

MCB-651BB  
Cutting Board

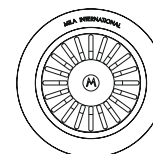

MKD-101SB  
Strainer

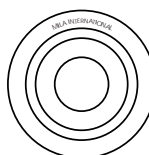

MDC-101SB  
Disposal Collar

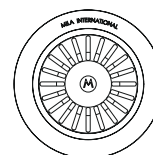

MDC-102SB  
Disposal Collar

PROJECT INFORMATION			
Project			
Date	/ /	QTY	
Specifier			
Contact			
Note			

UNDER-MOUNT