

# FLATIRON MUB-301P

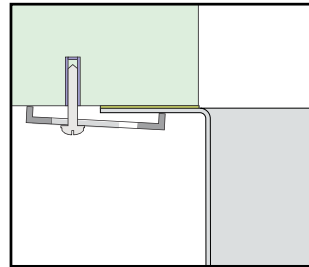

\*ADA compliant

- **FEATURES**  
16-gauge type 304 stainless steel
- **TECHNICAL INFORMATION**  
External dimension: 17"Lx15"Wx4"D  
Basin dimensions: 15"Lx13"Wx4"D
- **FINISHES**  
Polished Mirror Finish
- **INSTALLATION OPTIONS**  
Under-mount
- **MINIMUM CABINET SIZE (I.D.)**  
Under-mount 20"
- **DUAL-MOUNT INSTALLATION**

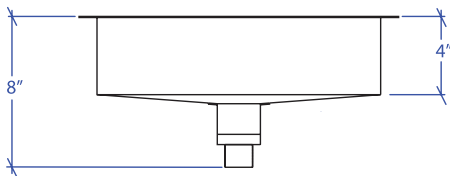
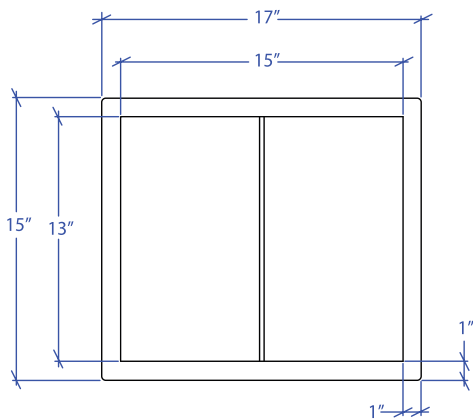

Under-mount

PROJECT INFORMATION			
Project			
Date	/ /	QTY	
Specifier			
Contact			
Note			