

ORION MOUS-801SB

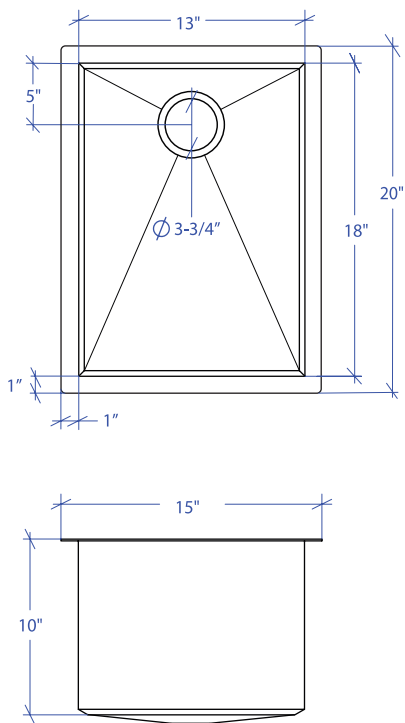

*Custom ADA compliant sinks are available



- **FEATURES**
16-gauge type 304 stainless steel
Bevel basin design
- **TECHNICAL INFORMATION**
External dimension: 15"Lx20"Wx10"D
Basin dimensions: 13"Lx18"Wx10"D
- **FINISHES**
Satin Brushed stainless steel
- **INSTALLATION OPTIONS**
Under-mount
- **MINIMUM CABINET SIZE (I.D.)**
Under-mount 18"

• US DESIGN PATENT D618,324 S

• DUAL-MOUNT INSTALLATION

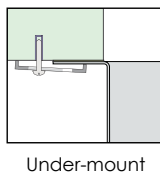

• ACCESSORY OPTIONS

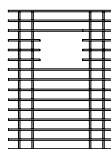

MBG-082SB
Basin Grid

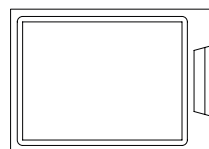

MCB-801BB
Cutting Board

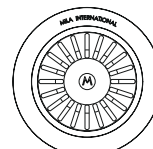

MKD-101SB
Strainer

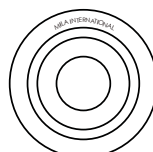

MDC-101SB
Disposal Collar

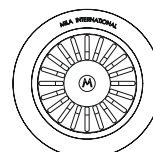

MDC-102SB
Disposal Collar

PROJECT INFORMATION			
Project			
Date	/ /	QTY	
Specifier			
Contact			
Note			