

ORION MOUS-654GDSB

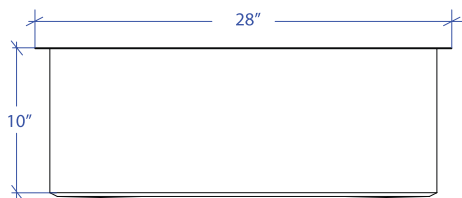

*Custom ADA compliant sinks are available

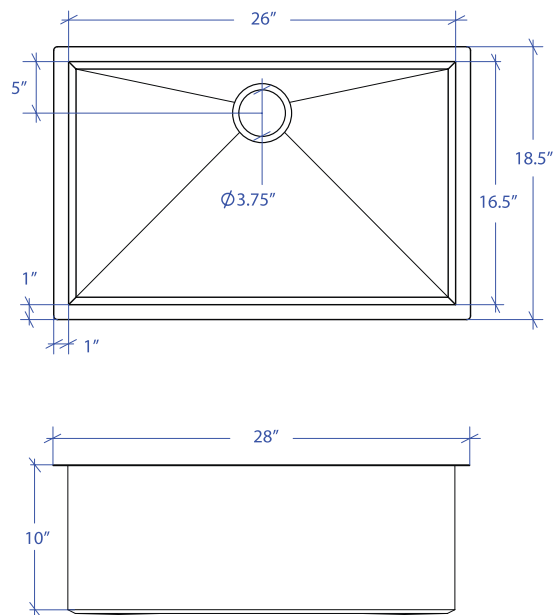

- **FEATURES**
16-gauge type 304 stainless steel
Bevel basin design
- **TECHNICAL INFORMATION**
External dimension: 28"Lx18.5"Wx10"D
Basin dimensions: 26"Lx16.5"Wx10"D
- **FINISHES**
Gold PVD Satin Brushed stainless steel
- **INSTALLATION OPTIONS**
Under-mount
- **MINIMUM CABINET SIZE (I.D.)**
Under-mount 31"

• US DESIGN PATENT D618,324 S

• DUAL-MOUNT INSTALLATION

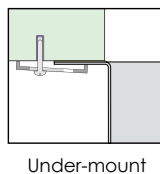

• ACCESSORY OPTIONS

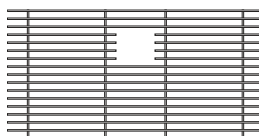

MBG-6510GDSB
Basin Grid

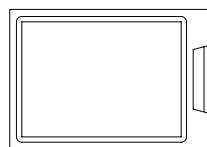

MCB-651BB
Cutting Board

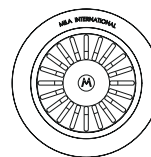

MKD-101GDSB
Strainer

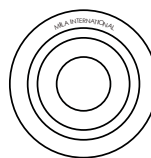

MDC-101GDSB
Disposal Collar

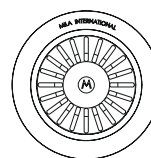

MDC-102GDSB
Disposal Collar

| PROJECT INFORMATION | | | |
|---------------------|-----|-----|--|
| Project | | | |
| Date | / / | QTY | |
| Specifier | | | |
| Contact | | | |
| Note | | | |