

ORION MOUD-803SB



*Custom ADA compliant sinks are available

- FEATURES**
 16-gauge type 304 stainless steel
 Bevel basin design
- TECHNICAL INFORMATION**
 External dimension: 33"Lx20"Wx10"D
 Basin dimensions:
 Left: 17"Lx18"Wx10"D
 Right: 13"Lx18"Wx10"D
- FINISHES**
 Satin Brushed stainless steel
- INSTALLATION OPTIONS**
 Under-mount
- MINIMUM CABINET SIZE (I.D.)**
 Under-mount 36"

• US DESIGN PATENT D618,324 S

• DUAL-MOUNT INSTALLATION

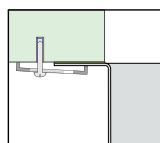

Under-mount

• ACCESSORY OPTIONS

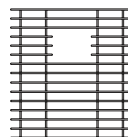

MBG-083SB
Basin Grid

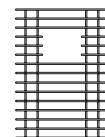

MBG-082SB
Basin Grid

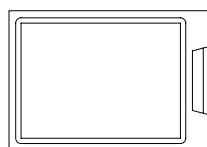

MCB-801BB
Cutting Board

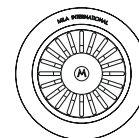

MKD-101SB
Strainer

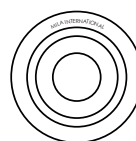

MDC-101SB
Disposal Collar

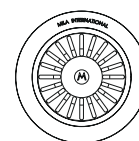

MDC-102SB
Disposal Collar

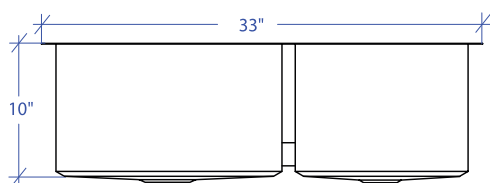
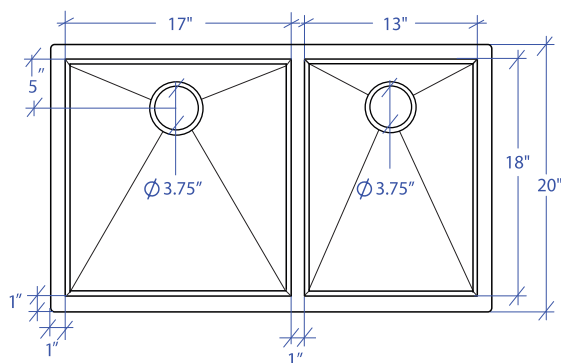

PROJECT INFORMATION			
Project			
Date	/ /	QTY	
Specifier			
Contact			
Note			