

WORKSTATION MFWS-637GDSB

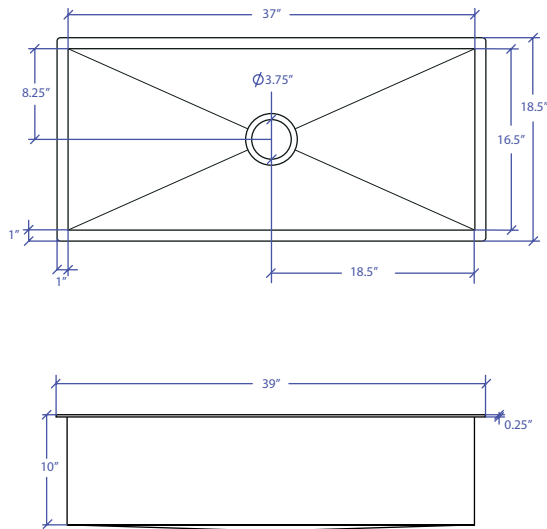

INDUSTRY'S ONLY STAINLESS STEEL SINK DESIGNED SPECIFICALLY TO BE FLUSH-MOUNTED



- FEATURES**
 16-gauge type 304 stainless steel
 5-gauge 304 stainless steel rim
- TECHNICAL INFORMATION**
 External dimension: 39" Lx18.5" Wx10" D
 Basin dimensions: 37" Lx16.5" Wx10" D
 Rim width: 1"
 Rim thickness: 1/4"
 Rim Corner: 1/4" round
- FINISHES**
 Gold PVD Satin Brushed stainless steel
- INSTALLATION OPTIONS**
 Flush-mount
- MINIMUM CABINET SIZE (I.D.)**
 Flush-mount 41"
- INSTALLATION TYPE**

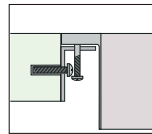

Flush-mount

INCLUDED ACCESSORIES



Flush Mount Kit
MTK-620AL

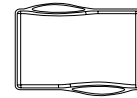

MWCB-651GDBB
Cutting Board

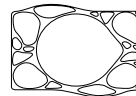

MWSM-651GDSB
Salad Mixer

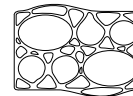

MWBM-651GDSB
Bain Marie

OPTIONAL ACCESSORIES

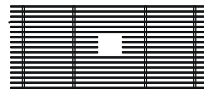

MBG-6519GDSB
Basin Grid



MWC-651GDSB
Colander



MWSS-651GDSB
Side Sink

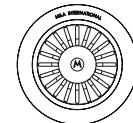

MKD-101GDSB
Strainer



MDC-101GDSB
Disposal Collar

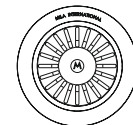

MDC-102GDSB
Disposal Collar

US Patent No. 9,988,799 CA Patent No. 2579506
International Patent Pending

PROJECT INFORMATION			
Project			
Date	/ /	QTY	
Specifier			
Contact			
Note			