

## 10 YEAR MANUFACTURER'S

### LIMITED WARRANTY

All parts of this Kingston Brass faucet are warranted to the original retail purchaser to be free from defects in material and workmanship for a period of Ten(10) years from the date of purchase as shown on the purchaser's receipt.

This warranty is limited to defective parts only, labor charges and/or damage resulting from improper installation, repair or replacements, as well as incidental and consequential damages connected therewith are excluded.

Any damage to this faucet as a result of misuse, abuse, neglect, accident, or improper installation or any use not consistent with the instructions furnished by us, will void this warranty.

Replacement parts can be obtained from your local dealer. Freight cost is not covered by manufacturer.

### **CAUTION!!!**

1. Water lines must be completely flushed before use, to avoid debris & clogs in your water system leading to mal-function and reduction of water flow.
2. Warranty is void if water lines are not flushed before use of a new faucet.
3. Use of abrasives of any strength may damage the finish of your faucet and void this warranty.

# **KINGSTON BRASS**

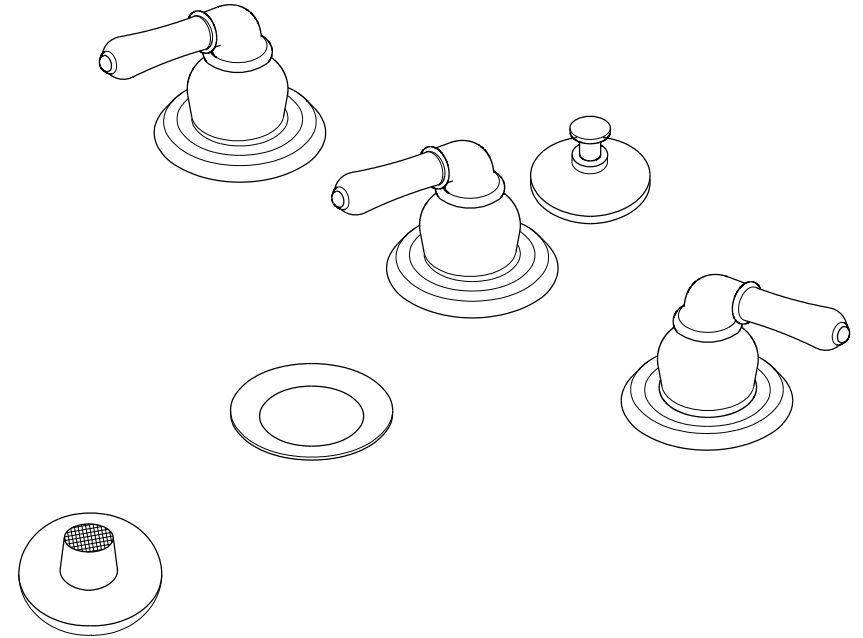

**THE TRADITION OF FINE BRASS**



### **PROBLEMS SHOOTING**

PROBLEM	CAUSE	CORRECTIVE ACTION
Leaks underneath handle	Bonnet nut has come loose	Remove the handle and tighten the bonnet nut
Leaks from the spout	Valve seat and spring are worn	Replace the valve seat and spring
Inconsistent water flow pattern	Aerator is dirty or aged	Release aerator and check on rubber gasket if aged or replace with a new aerator
Faucet is dirty	Caused by stubborn water spot	Clean with mild soap and warm water as often as possible
Handles work backward	Handle installed backward	Rotate the right stem stop assembly 180 degrees

### **Parts:**

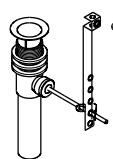
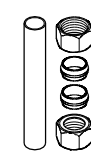
Washer & Lock Nut	Cone Washer & Coupling Nut	Pop Up	Tube & Nut & Gasket
			
2 Pcs	2 Pcs	1 Pc	2 Pcs

[www.kingstonbrass.com](http://www.kingstonbrass.com)

**TOLL-FREE CUSTOMER SERVICE: 1-877-2-KBRASS**  
**TECHNICAL SUPPORT E-mail: [service@kingstonbrass.com](mailto:service@kingstonbrass.com)**  
 12775 Reservoir Street, Chino, CA91710

# KINGSTON BRASS

THE TRADITION OF FINE BRASS

## INSTALLATION INSTRUCTIONS

### For Use With KB's Three-Handles Bidet Faucet with Pop-Up

#### BEFORE BEGINNING INSTALLATION

1. Flush plumbing lines to clear any debris.
2. Shut off both supply lines after flushing.
3. Kingston Brass recommends that you use Teflon's tape on every threaded connection.

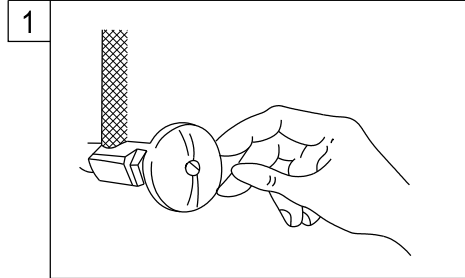

1. Shut off hot and cold water supply under sink. Plug sink drain with cloth to avoid losing small parts. Remove old faucet.

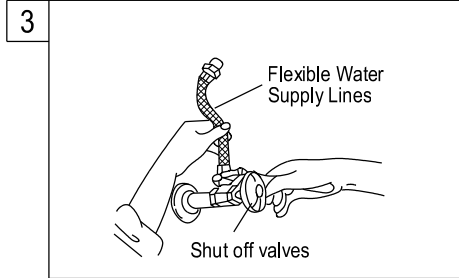

3. Apply Teflon tape to threads on faucet shank and shut off valves, connect water supply line.

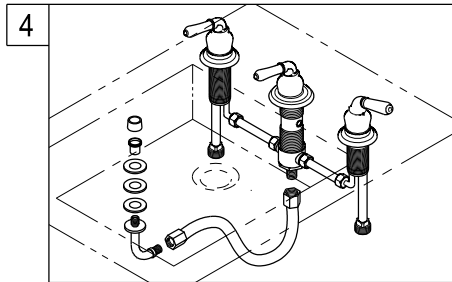

4. **BIDET DOUCHE ASSEMBLY INSTRUCTIONS**  
Unscrew jet stream adapter from douche assembly and remove second rubber washer and the metal washer. Place a bead of silicon around the opening of the hole to prevent possible leaks. While holding douche assembly from underneath, place rubber and metal washer over threaded portion of the assembly. Thread jet stream adapter onto the threaded end of the douche assembly and tighten until secure.

- FLEXIBLE HOSE INSTALLATION**  
First take the longest of your three flex hoses and attach one end to the bottom of the diverter valve tee and the other to the douche assembly. Next, use the other two hoses and attach one end to the cold/hot side and the other end to the side inlets of the tee that is connected to the bottom of the diverter valve. The best way to attach the hoses to the diverter tee is to have a small loupe on each side, but be careful not to kink the hose.

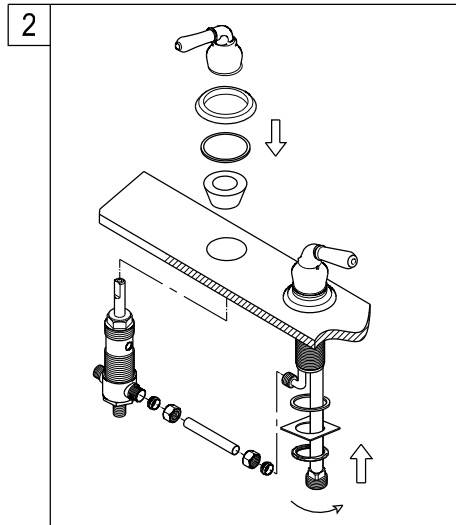

2. **DIVERTER INSTALLATION**  
First remove the handle, top rubber cone washer and flat metal washer from the diverter valve and insert into center hole from underneath. While holding body in place install second cone washer from the top of the valve and make sure that the two cone washers make a solid connection. Then use the threaded flange to secure the body to the bidet basin. Tighten locknut from the bottom half of the body until it is secure. Reattach diverter handle and tighten set screw.

#### COLD & HOT BODY INSTALLATION

Remove handle assembly by releasing set screw with Allen wrench. Then remove flange by turning counter clockwise. Place body through hole from underneath and hold in place as you attach the flange. Then tighten locknut and washer from underneath until secured. Attach handle and tighten set screw. Repeat steps for opposite side.

#### Need Tools:

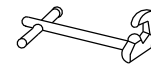

Basin Wrench



Adjustable Wrench



Teflon Tape

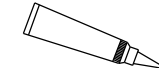

Silicone Sealant

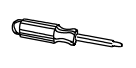

Screwdriver

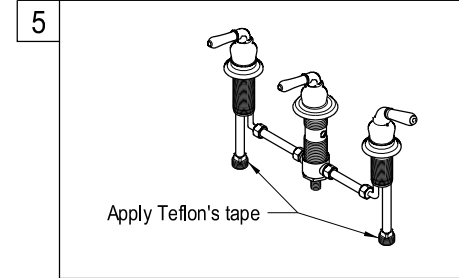

5. Apply Teflon's tape to inlet shanks and connect supply lines.

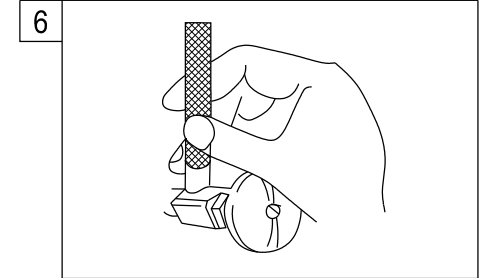

6. Turn on water supply valves and check for leaks, especially all supply line connections.

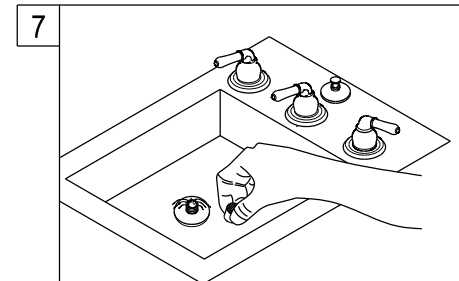

7. Remove the aerator before turning on your new faucet for the first time, let hot and cold water run for at least 1 minute, replace aerator this will prevent debris in the line from clogging the aerator.

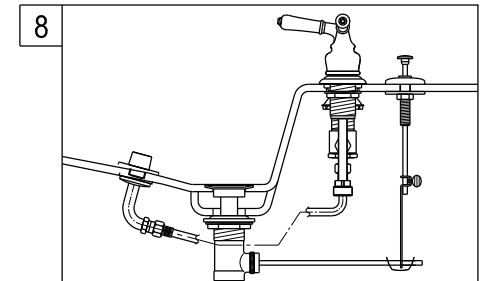

#### POP-UP DRAIN INSTALLATION

##### INSTALLATION:

1. Remove the drain flange(2) and drain plug(1) and rubber(3) from pop-up assembly.
2. Apply a small bead of silicone caulking (Do not use Plumbers putty) under drain flange.
3. Insert threaded end of pop-up assembly from underneath the sink.
4. Thread the drain flange(2) on top of pop-up assembly, making sure to position side hole towards the rear wall.
5. Insert drain plug(1) aligning the bottom hole with the side hole.
6. Insert small side of ball rod in side hole, making sure that the rod goes through bottom hole of drain plug.
7. Apply Teflon tape ball rod thread connection. Tighten nut so that ball rod (8) moves loosely, do not over tighten.
8. Insert pop-up rod(9) through the top portion of lift rod strap(11) and tighten thumb screw(10).
9. Push the ball rod down, this will make drain plug go up.
10. Insert one side of ball rod clip(12).
11. Insert lift rod strap onto ball rod.
12. Slide other side of ball rod clip.
13. Test movement of pop-up, if necessary adjust by loosening thumb screw and tightening in a position that will give you smooth movement. Lift rod strap may also be used for adjustment.
14. Turn handles on faucet to the full on position and inspect to insure that there is no leaking underneath lavatory.

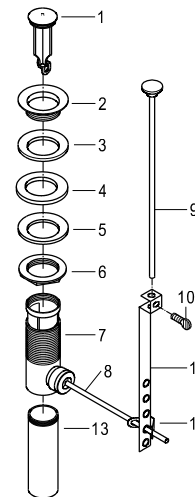

## Parts:

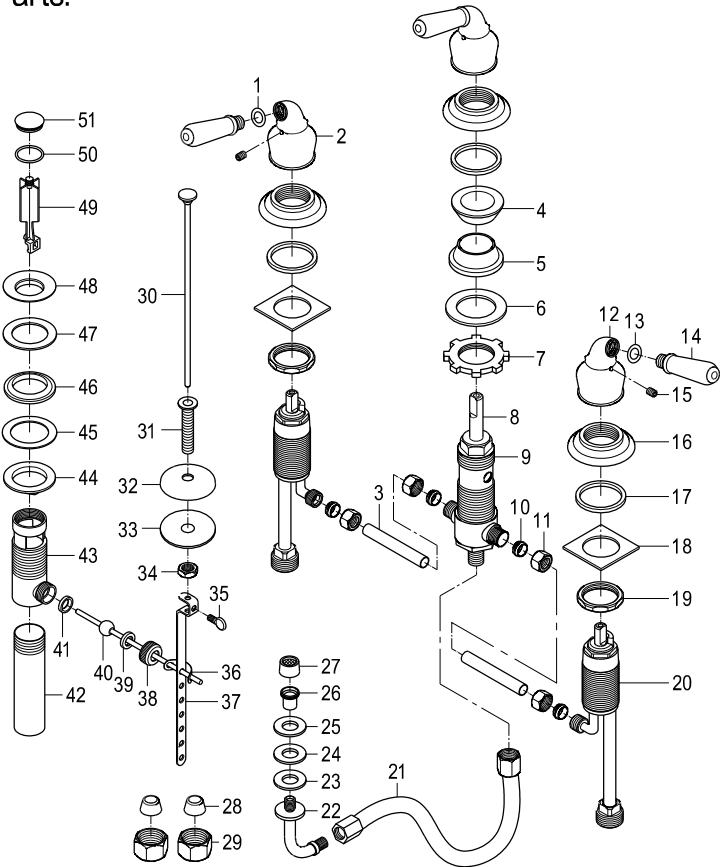

## Replacement Parts:

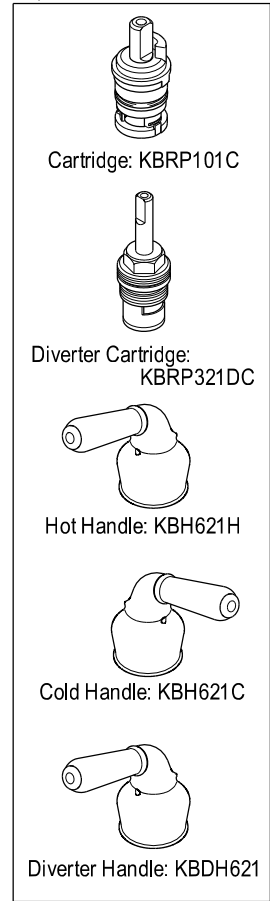

## Kingston Brass™ Faucets

### (10) YEARS LIMITED WARRANTY

Kingston Brass warrants its faucets to be flawless during normal residential use. If the faucet should leak or drip during normal use, Kingston Brass will, free of charge, mail to the original owner the cartridge necessary to put the faucet in good working condition. All warranty parts to be shipped freight prepaid ground service. Customer will be responsible for all warranty part freight charges if express shipping is requested. This warranty applies only to Kingston Brass Faucets installed in the United States of America only.

Kingston Brass also warrants all other aspects of the faucet or accessories (except Oil Rubbed Bronze and Dark Bronze Finishes on color changes as part of the normal living finish behavior) to be free of defects in material and workmanship during normal residential use within (10) years from the date of purchase to its original owner. If a defect is found in normal residential use, Kingston Brass will, at its selection, repair, provide a replacement part or product, or make appropriate adjustment. Damage to a product caused by accident, misuse, or abuse is not covered by this warranty. Improper care and cleaning will void the warranty. Proof of purchase (original sales receipt) must be provided to Kingston Brass with all warranty claims. Kingston Brass is not responsible for labor charges, installation, or other incidental or consequential costs. In no event shall the liability of Kingston Brass exceed the purchase price of the faucet.

### SPECIAL FINISHES:

Warranty does not apply to special or living surface finishes such as Oil Rubbed Bronze, Dark or Old Bronze as living finishes will change over time as a result of a normal process and may look different than at the time of purchase, therefore these items are warranted for functionality only. Oil Rubbed Bronze, Dark or Old Bronze components may vary in shade at the time of shipment. This warranty is limited to the replacement of defective parts only, labor charges and/or damage resulting from improper installation, repair or replacements, as well as incidental and consequential damages connected therewith are excluded. Any damage to this faucet as a result of misuse, abuse, neglect, accident or improper installation or any use not consistent with the instructions furnished by us, will void this warranty.

### CAUTION!!!

1. Prior to installing the faucet, water lines must be flushed clean of debris and particles that may be present to avoid the clogging of cartridges or aerator causing mal-function, leakage or reduce in flow.
2. Warranty will be void if water lines are not properly flushed prior to installing the faucet.
3. Use of abrasives cleaners of any strength may damage the finish of your faucet and will void this warranty. To obtain warranty service, contact the Dealer, Plumbing Contractor, Home Center or E-tailer, or contact Kingston Brass by calling 1-877-252-7277 or write to Attn: Warranty Department, 12775 Reservoir Street, Chino, CA 91710.

## Kingston Brass™ Cast Iron Tubs, Acrylic Tubs, Toilets, Vessel Sinks, Wash Basins, and Stainless Steel Sinks.

### ONE-YEAR LIMITED WARRANTY

KINGSTON BRASS Sinks, tubs and toilets are warranted to be free of defects in material and workmanship for one year from date of installation. Kingston Brass will, at its selection, repair, replace or make appropriate adjustment where Kingston Brass inspection discloses any such defects occurring in normal usage within one(1) year after purchase to its original owner. Proof of purchase (original sales receipt) must be provided to Kingston Brass with all warranty claims. Kingston Brass is not responsible for removal or installation costs. Use of in-tank toilet cleaners will void the warranty.

To obtain warranty service, contact the Dealer, Plumbing Contractor, Home Center or E-tailer, or contact Kingston Brass by calling 1-877-252-7277 or write to Attn: Warranty Department, 12775 Reservoir Street, Chino, CA 91710.

Some states/provinces do not allow limitations on how long an implied warranty lasts, or the exclusion or limitation of special, incidental or consequential damages, so these limitations and exclusions may not apply to you. This warranty gives you specific legal rights. You may also have other rights which vary from state/province to state/province.

\* Never use cleaners containing abrasive cleansers, ammonia, bleach, acids, waxes, alcohol, solvents or other products not recommended for chrome. This will void the warranty.

## CARE AND MAINTENANCE OF YOUR FAUCET

Your Kingston Brass faucet has been finished to the most strict standards; however, due to the high content of minerals in the water, your finish may appear dull and tarnished after time. These are some do's and don'ts to maintain the luster on your faucet for many years to come.

### DO

1. Use a silicon based caulking when installing.
2. Clean your faucet with only a mild soap and water solution.
3. Dry your faucet after using it.
4. Give it a coat of Carnauba Wax periodically.

### DON'T

1. Use plumbers putty when installing the faucet.
2. Use any abrasive cleaning agents.

It may seem like a very simple and short list but it is that simple to maintain your faucet, looking shiny and new.

If your faucet is already looking somewhat dull and tarnished, before replacing, try cleaning it with a 50/50 solution of vinegar and water, you may need to soak some rags and wrap around those stubborn areas, leave overnight and rinse completely in the morning, apply Carnauba wax once you have removed the mineral deposits.