

10 YEAR MANUFACTURER'S

LIMITED WARRANTY

All parts of this Kingston Brass faucet are warranted to the original retail purchaser to be free from defects in material and workmanship for a period of Ten(10) years from the date of purchase as shown on the purchaser's receipt.

This warranty is limited to defective parts only, labor charges and/or damage resulting from improper installation, repair or replacements, as well as incidental and consequential damages connected therewith are excluded.

Any damage to this faucet as a result of misuse, abuse, neglect, accident, or improper installation or any use not consistent with the instructions furnished by us, will void this warranty.

Replacement parts can be obtained from your local dealer. Freight cost is not covered by manufacturer.

CAUTION!!!

1. Water lines must be completely flushed before use, to avoid debris & dlogs in your water system leading to mal-function and reduction of water flow.
2. Warranty to be void if water lines are not flushed before use of new faucet.
3. Use of abrasives of any strength may damage the finish of your faucet and void this warranty.

PROBLEMS SHOOTING

PROBLEM	CAUSE	CORRECTIVE ACTION
Leaks underneath handle	Bonnet nut has come loose	Remove the handle and tightening the bonnet nut
Leaks from the spout	Valve seat and spring are worn	Replace the valve seat and spring
Inconsistent water flow pattern	Aerator is dirty or aged	Release aerator and check on rubber gasket if aged or replace with new aerator
Faucet is dirty	Caused by stubborn water spot	Clean with mild soap and warm water as often as possible
Handles works backward	Handle install backward	Rotate the right stem stop assembly 180 degrees



CODE APPROVAL: LA#M-000018

KINGSTON BRASS

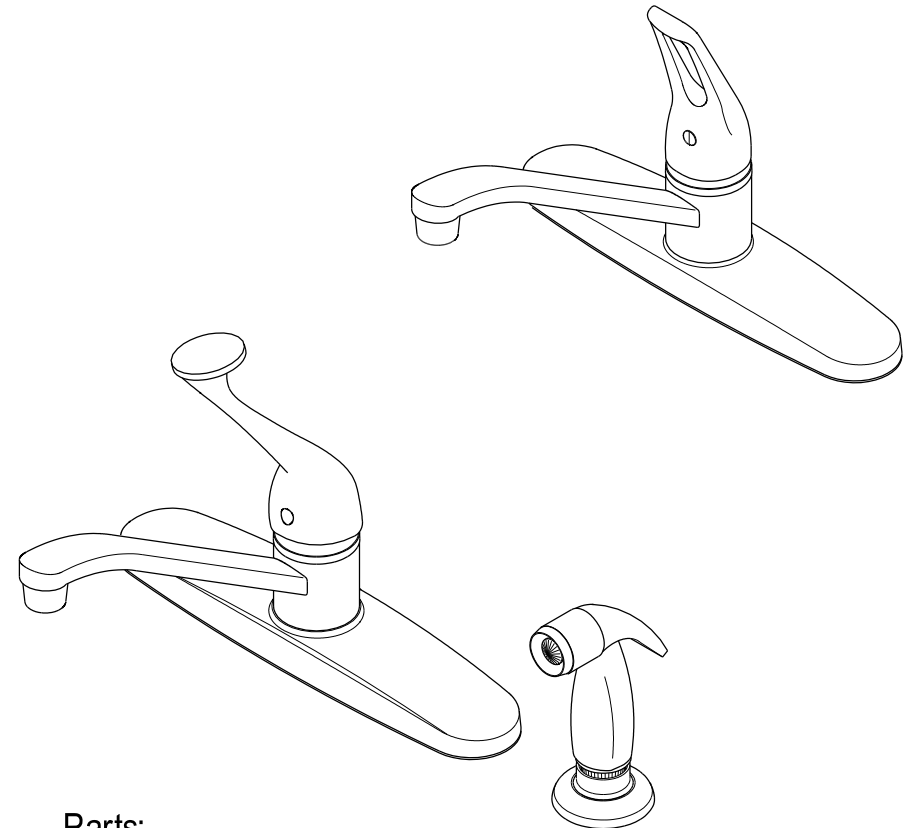
THE TRADITION OF FINE BRASS



Parts:

Stud & Lock Nut	Cone Washer & Coupling Nut
	
X2	X2

www.kingstonbrass.com

TOLL-FREE CUSTOMER SERVICE: 1-877-2-KBRASS

TECHNICAL SUPPORT E-mail: service@kingstonbrass.com

12775 Reservoir Street, Chino, CA91710

INSTALLATION INSTRUCTIONS

For Use With KB's Single Handle Kitchen Faucets with or without Sprayer

Before Beginning Installation.

- 1 Flush plumbing lines to clear debris in pipe and plumbing lines to avoid existing clogs into waterway & cartridge system of new faucet fixture.
2. Shut off both supply lines after flushing

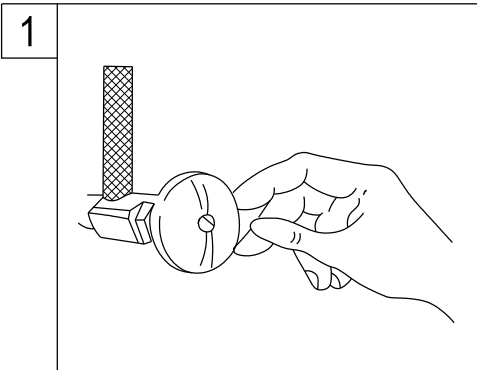
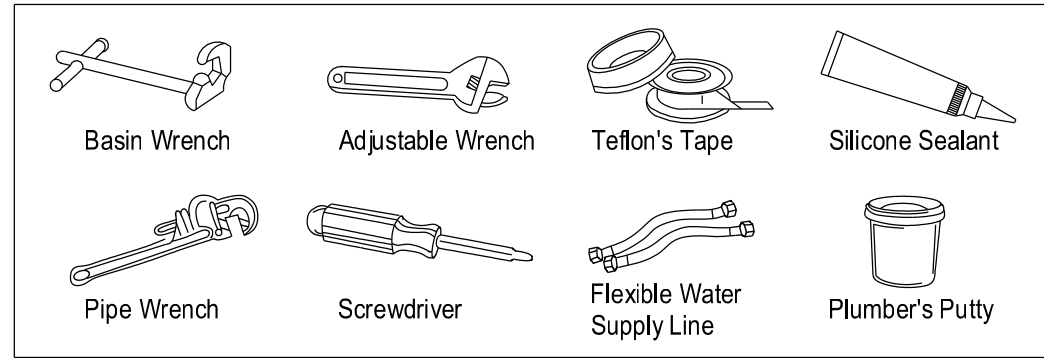

1. Shut off hot and cold water supply under sink. Plug sink drain with cloth to avoid losing small parts. Remove old faucet.

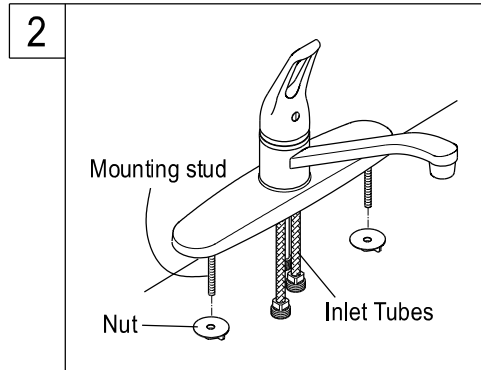

2. Set the faucet in place, insert the inlet shanks through the sink holes, and press down. Assemble the mounting stud and nuts on the inlet shanks, and then tighten the nuts with hand.

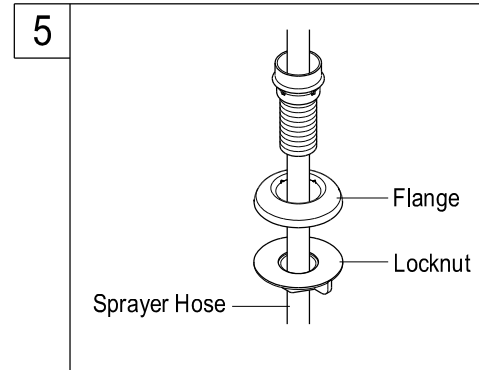

5. For model is with spray head and hose. Place the spray guide through the fourth hold in the sink, screw the locknut onto the shank and tighten firmly.

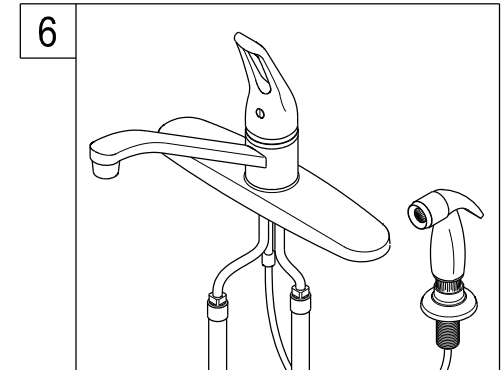

6. Insert the hose through the guide and attach to the fitting on the bottom of the faucet. Attach spray head to the hose.

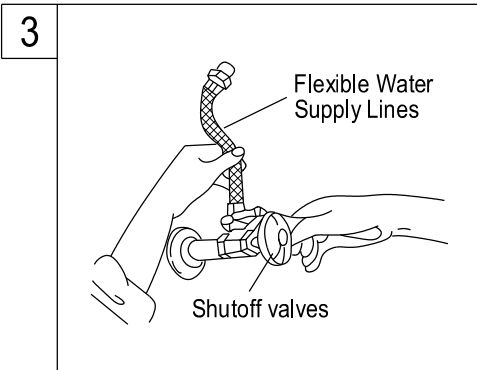

3. Connect the water supply lines. Before connecting the supply lines, apply pipe joint compound to the threads on the inlet shanks and shut off valves.

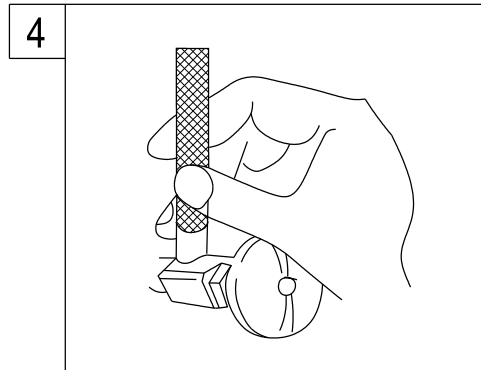

4. Turn on water supply valves and check for leaks, especially at hook-ups to supply lines.

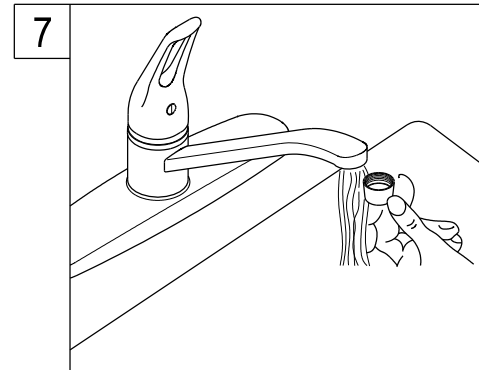

7. Remove the aerator before turning on your new faucet for the first time. This is to prevent any deposits from clogging your aerator. Allow both hot and cold water to run for one minute. Replace aerator.