

KALLISTA®

Bezel™ by CRISTINA Rubinetteria Bezel™ Wall Mount Single Control Sink Faucet P33166-00

Features

- High-quality solid-brass construction for durability and reliability
- Faceted knob handle design with precision alignment
- Single-handle control
- Spout reach is 7-1/8" (181 mm)
- 1.2 gpm (4.5 lpm) maximum flow rate
- Includes quiet clicker drain
- Required rough-in sold separately

Required Products/Accessories

For wall-mount installation

P32716-00 Wallmount Single Control Rough In

Recommended Products/Accessories

P32742-00 Bezel™ 18" Towel Bar

P32744-00 Bezel™ 12" Towel Bar

P32745-00 Bezel™ Robe Hook

P32746-00 Bezel™ Toilet Paper Holder

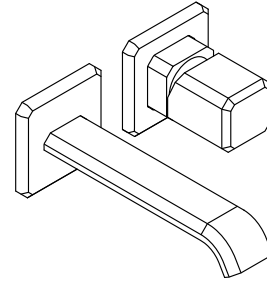

Codes/Standards

ASME A112.18.1/CSA B125.1

NSF/ANSI/CAN 61

NSF/ANSI/CAN 372

DOE - Energy Policy Act 1992

EPA WaterSense®







California Energy Commission (CEC)

KALLISTA® Five-Year Limited Warranty

See website for detailed warranty information.

Available Colors/Finishes

Color tiles intended for reference only.

Color	Code	Description
	CP	Polished Chrome
	BLH	Blush Brass
	2MB	Brushed Moderne Brass
	BN	Brushed Nickel
	BGP	Brushed Graphite
	PGP	Polished Graphite

1-888-4-KALLISTA (1-888-452-5547)

Kallista reserves the right to make revisions without notice to product specifications.

For the most current Specification Sheet, go to www.kallista.com.

1-30-2025 12:20 - US/CA

KALLISTA®

Bezel™ by CRISTINA Rubinetterie Bezel™ Wall Mount Single Control Sink Faucet P33166-00

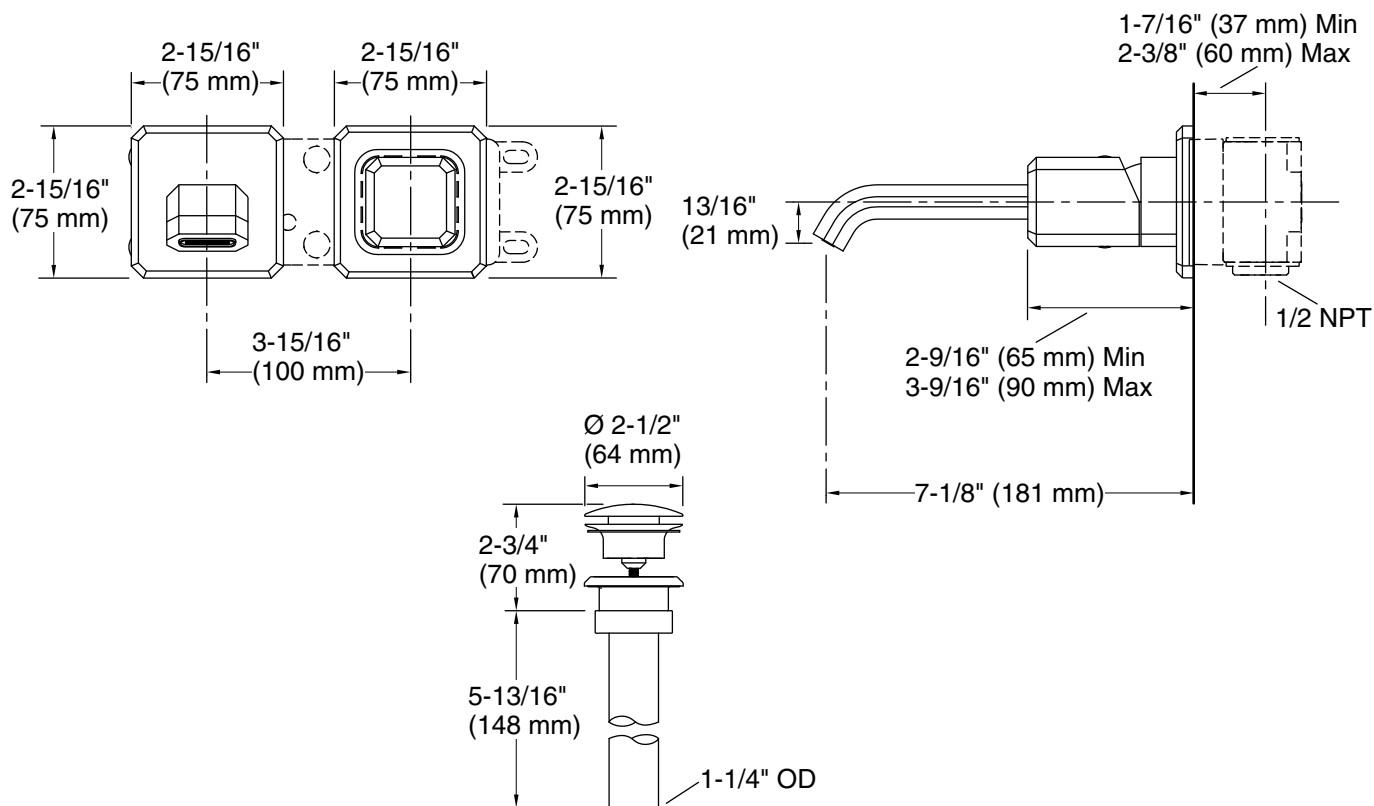

Technical Information

All product dimensions are nominal.

Faucet flow rate: 1.2 gal/min (4.5 l/min)

Drain included: Yes

Drain with overflow: Yes

Spout:

Spout reach: 7-1/8" (181 mm)

Notes

Install this product according to the installation instructions.