

KALLISTA®

Aileron™ by CRISTINA Rubinetterie Aileron™ Wall Mount Bath Spout P32833-00

Features

- High-quality solid-brass construction for durability and reliability
- 9-1/8" (232 mm) spout reach
- 1/2" NPT connection

Recommended Products/Accessories

- P32939-00 Modern Round Showerhead with Arm
- P33495-00 Aileron™ Stacked 2-Outlet Thermostatic Trim
- P33496-00 Aileron™ Stacked 3-Outlet Thermostatic Trim
- P50045-00 Large Rectangular Bathtub

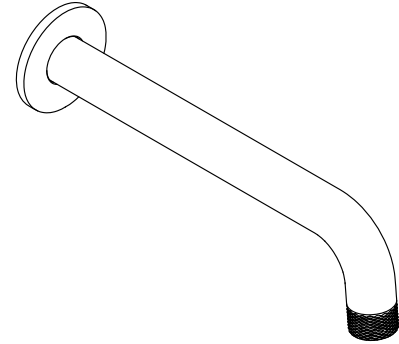

Codes/Standards







ASME A112.18.1/CSA B125.1

KALLISTA® Five-Year Limited Warranty

See website for detailed warranty information.

Available Colors/Finishes

Color tiles intended for reference only.

Color	Code	Description
	CP	Polished Chrome
	BL	Matte Black
	BLH	Blush Brass
	2MB	Brushed Moderne Brass
	BGP	Brushed Graphite
	BN	Brushed Nickel

1-888-4-KALLISTA (1-888-452-5547)

Kallista reserves the right to make revisions without notice to product specifications.

For the most current Specification Sheet, go to www.kallista.com.

3-19-2025 20:52 - US/CA

KALLISTA®

Aileron™ by CRISTINA RubINETterie
Aileron™ Wall Mount Bath Spout
P32833-00

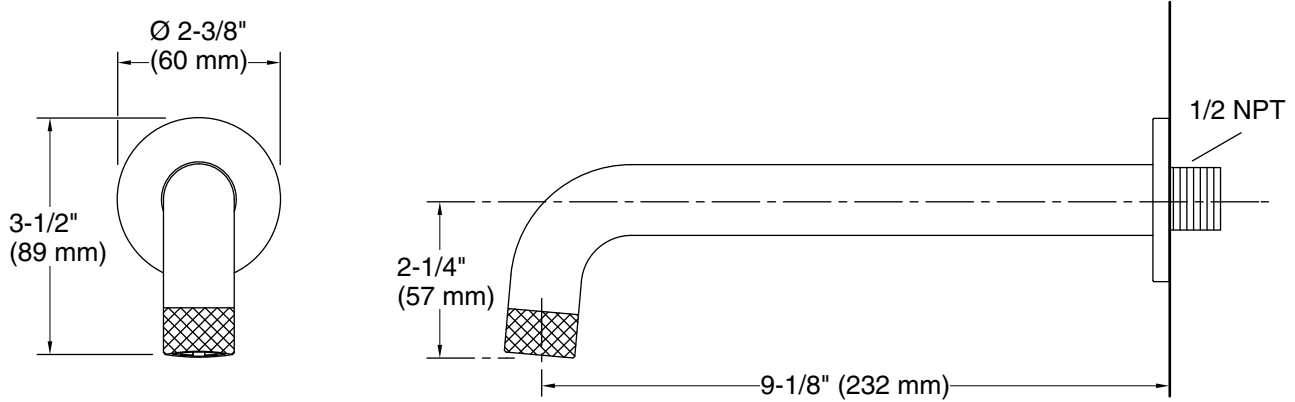

Technical Information

All product dimensions are nominal.

Spout:

Spout reach: 9-1/8" (232 mm)

Notes

Install this product according to the installation instructions.