

Features

- Enables water diversion from bath faucet to handshower
- High-quality solid-brass construction for durability and reliability
- Required rough-in sold separately
- Unlacquered Brass (ULB) available in North America and the United Kingdom only

Required Products/Accessories

P20995-00 Deck-Mount Diverter Valve

Recommended Products/Accessories

P50047-00 Small Rectangular Bathtub
P21930-00 Contemporary Drain Trim Kit
P34407-00 Disc Hook
P21834-00 Wall-mount bath spout



ADA **CSA B651** **OBC**

Codes/Standards











ASME A112.18.1/CSA B125.1
ADA
ICC/ANSI A117.1
CSA B651
OBC

KALLISTA® Five-Year Limited Warranty

See website for detailed warranty information.

Available Colors/Finishes

Color tiles intended for reference only.

Color	Code	Description
	CP	Polished Chrome
	GN	Gunmetal
	BL	Matte Black
	ULB	Unlacquered Brass
	BAF	Brushed French Gold
	BGP	Brushed Graphite
	BN	Brushed Nickel
	PGP	Polished Graphite
	SN	Polished Nickel
	2MB	Brushed Moderne Brass

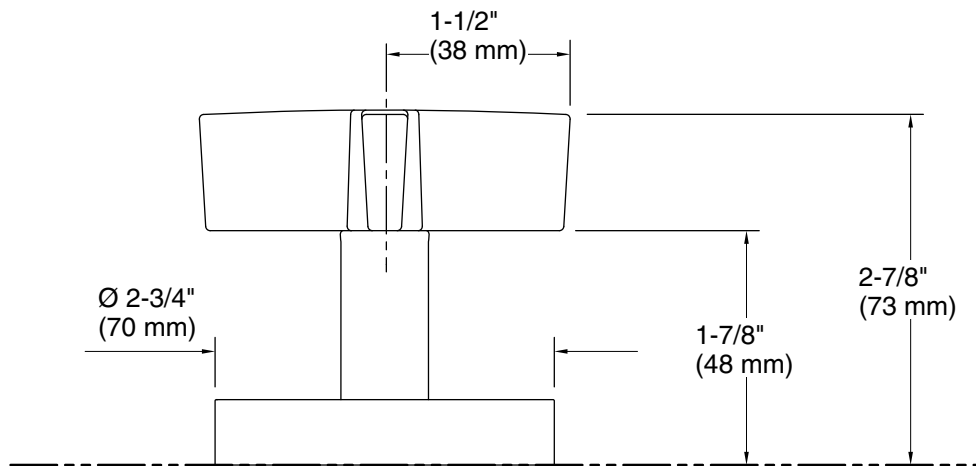

Technical Information

All product dimensions are nominal.

Notes

ADA, OBC, CSA B651 compliant when installed to the specific requirements of these regulations.