

Features

- A selection of products within this collection is in stock and ready to ship. Please visit kallista.com/readytoship for the complete list of Ready-to-Ship products and finishes
- High-quality solid-brass construction for durability and reliability
- Maintains water temperature within +/-3 degrees Fahrenheit
- Features a high-temperature-limit stop to help prevent scalding
- Required rough-in sold separately

Required Products/Accessories

- P19310-00 Pressure Balance Rough-In
 or
 P19310-WS Pressure Balance Rough-In Valve With Stops
 or
 P29306-WS High Flow Pressure Balance Rough-In Assembly



ADA **CSA B651** **OBC**

Codes/Standards











ASME A112.18.1/CSA B125.1
 ADA
 ICC/ANSI A117.1
 CSA B651
 OBC

KALLISTA® Five-Year Limited Warranty

See website for detailed warranty information.

Available Colors/Finishes

Color tiles intended for reference only.

Color	Code	Description
	CP	Polished Chrome
	GN	Gunmetal
	BL	Matte Black
	ULB	Unlacquered Brass
	BAF	Brushed French Gold
	BGP	Brushed Graphite
	BN	Brushed Nickel
	PGP	Polished Graphite
	SN	Polished Nickel
	2MB	Brushed Moderne Brass

KALLISTA

One™ by KALLISTA
Pressure balance trim, cross handle
P24415-CR

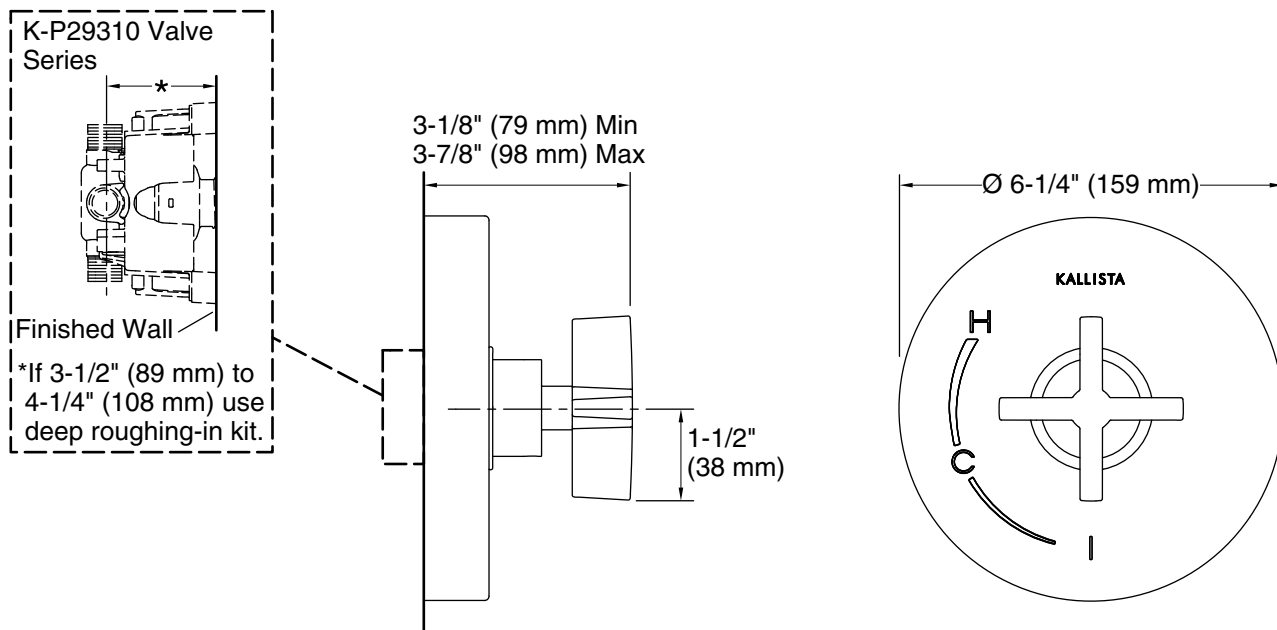

Technical Information

All product dimensions are nominal.

Notes

ADA, OBC, CSA B651 compliant when installed to the specific requirements of these regulations.