

INSTALLATION INSTRUCTIONS

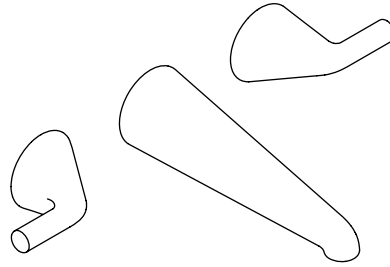

P24810

INSTALLATION INSTRUCTIONS

THANK YOU FOR CHOOSING KALLISTA

We appreciate your commitment to KALLISTA quality products. Please take a moment to review this manual before you install your KALLISTA product. If you encounter any installation or performance problems, please do not hesitate to contact us at the phone number listed at the bottom of the page.

BEFORE YOU BEGIN

- Shut off the water supply.
- Observe all local plumbing and building codes.
- If needed, complete the finished wall before beginning this installation.
- KALLISTA reserves the right to make revisions in the design of products without notice, as specified in the Price Book.

TOOLS AND MATERIALS

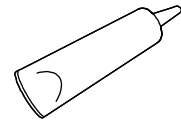
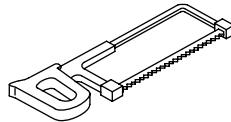
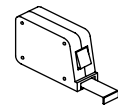
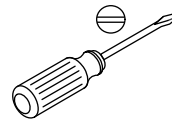
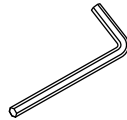
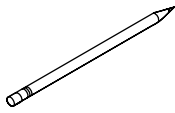

T-Handle 7/64"
Hex Wrench

Hacksaw

Shower Valve
Socket Wrench

Silicone
Sealant

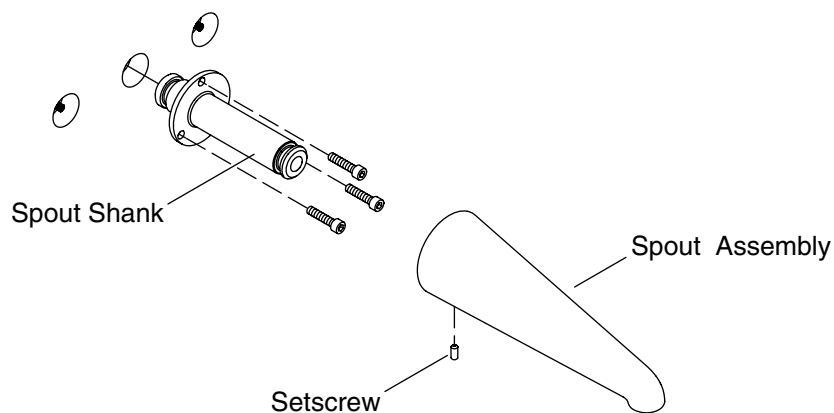
INSTALLATION INSTRUCTIONS**1. SPOUT ASSEMBLY**

NOTE: To avoid dropping the screws behind the finished wall, use a magnetic wrench or tape the screw to the wrench. (A T-handle hex wrench is recommended.)

- Attach the spout shank to the valve with the three socket head screws (provided).
- Slide the spout assembly over the spout shank so the aerator is pointing down.
- Secure the spout by firmly tightening the setscrew.
- If desired, apply a bead of clear silicone sealant around the spout.

INSTALLATION INSTRUCTIONS

2. INSTALL THE HANDLES

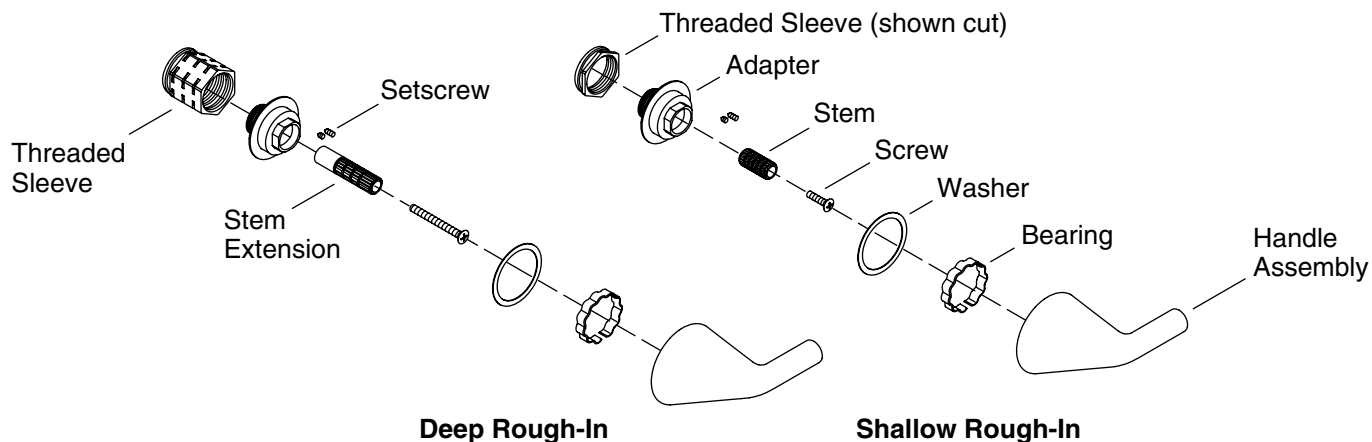

NOTE: Avoid dropping the threaded sleeve behind the finished wall. (A shower valve socket wrench is recommended.)

- Thread the threaded sleeve all the way onto the valve.
- Mark the sleeve where it will be flush with the finished wall.
- Remove the sleeve.
- Cut the sleeve at one of the notches closest to the mark, on the inside edge.
- Reinstall the threaded sleeve onto the valve.
- Apply a bead of silicone sealant to the underside of the adapter.
- Thread the adapter onto the threaded sleeve, flush against the finished wall.
- Remove excess sealant.
- Install the longer setscrew into the adapter and tighten. If the setscrew protrudes above the surface of the adapter, use the shorter setscrew.
- Install the stem extension on the valve stem with the screw.
- Install the washer and bearing onto the adapter.

Check Handle Alignment:

- Ensure both valves are turned off.
- With both handles positioned horizontally, engage the internal spline in the handle assemblies with the stem extensions.
- Check the handles for proper horizontal orientation.
- If the handles are not in the proper orientation, remove the handles and stem extension or stem. Rotate the stem extension or stem slightly and reinstall. Reinstall handles and check for proper orientation. Repeat until proper orientation is achieved.
- Ensure the stem extension or stem is secured tightly by the screw and reinstall the handles.
- Place the handle assembly into the stem extension or stem. Verify handle orientation.

INSTALLATION INSTRUCTIONS

INSTALL THE HANDLES (CONTINUED)

- Place the handle assembly into the stem extension or stem. Verify handle orientation.
- Install the handle onto the adapter.
- Repeat with the other handle.

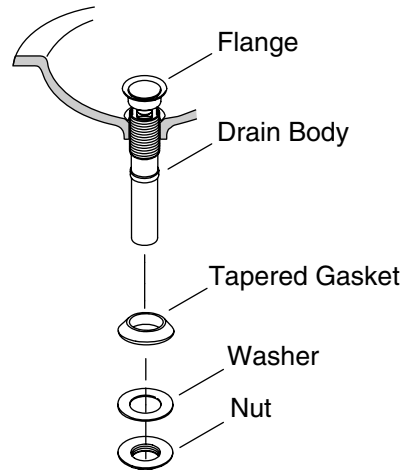
INSTALLATION INSTRUCTIONS**3. INSTALL THE DRAIN**

- If present, remove the protective plastic cap from the drain and discard.
- Remove the nut, washer, and gasket from the drain body.
- Apply a bead of plumbers putty or other sealant around the underside of the flange according to the sealant manufacturer's instructions.
- For drains with metal stoppers: Close the drain and rotate the drain body until the logo is positioned horizontally.
- Insert the drain into the drain hole and press into place.
- Slide the gasket (tapered side up) onto the drain body.
- Slide the washer over the threads on the drain body.
- Thread the nut up the drain body until snug against the underside of the lavatory. Use care not to rotate the drain while tightening the nut.
- Using a wrench, tighten the nut.
- Remove any excess putty or sealant.
- Connect the P-trap to the drain body.

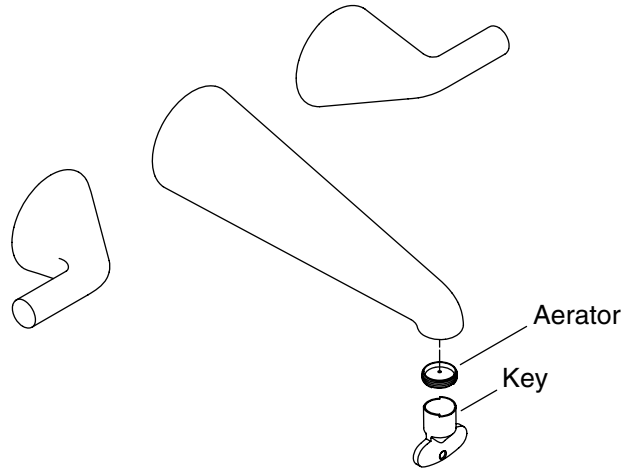
INSTALLATION INSTRUCTIONS**4. INSTALLATION COMPLETION**

- Ensure both faucet handles are turned off.
- Turn on the water supplies and check the installation for leaks.
- Repair as needed.
- Remove the aerator with the aerator key.
- Open the valves and run water through the spout for a minute to remove any debris.
- Turn off the valves and reinstall the aerator.
- Keep the aerator key for future use.