

Quarter Turn Straight Pattern 1/2" Copper (Sweat Fit) x 1/2" O.D. Supply Valve with Contempo Lever Handle



Model #: 635-2-

FEATURES:

- Straight pattern copper sweat x 1/2" O.D. quarter turn ball valve
- 1/2" sweat inlet x 1/2" O.D. outlet
- 5" cover tube slides over 1/2" copper pipe
- Fully finished bell escutcheon P/N 7116 included



AVAILABLE FINISHES:

Polished Chrome (PCH)	Satin Chrome (SC)	Bronze Umber (BU)
Satin Nickel (SN)	Pewter (PEW)	Caramel Bronze (CB)
Polished Nickel (PN)	Antique Brass (AB)	Antique Copper (ACU)
Oil-Rubbed Bronze (ORB)	Polished Brass (PB)	Polished Copper (PCU)
Vintage Bronze (VB)	Satin Brass (SB)	Rose Gold (RG)
Matte Black (MBK)	Satin Gold (SG)	Polished Gold (PG)
Black Nickel (BKN)	Bombay Gold (BG)	Jewelers Gold (JG)
Europa Bronze (EB)	White (WH)	Sedona Beige (SDB)
Tristan Brass (TB)	Satin Cooper (SCU)	

SPECIFICATION DRAWING:

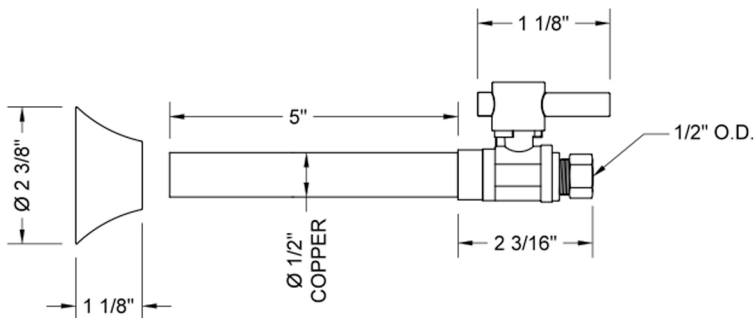

AVAILABLE HANDLES:



COMPLIANCES:

Complies with: ASME A112.18.1-2012/CSA B125.1-12