

Extra Long Thread Toe Control Tub Drain Strainer (3" Long)

Model #: 529-75-

FEATURES:

- 3" long coarse threads for thick tubs
- Forged brass cap (2" diameter)
- Brass body
- 1 1/2" Coarse threads
- Fits JACLO, Gerber and most other manufacturers



AVAILABLE FINISHES:

Polished Chrome (PCH)	Satin Chrome (SC)	Bronze Umber (BU)
Satin Nickel (SN)	Pewter (PEW)	Caramel Bronze (CB)
Polished Nickel (PN)	Antique Brass (AB)	Antique Copper (ACU)
Oil-Rubbed Bronze (ORB)	Polished Brass (PB)	Polished Copper (PCU)
Vintage Bronze (VB)	Satin Brass (SB)	Rose Gold (RG)
Matte Black (MBK)	Satin Gold (SG)	Polished Gold (PG)
Black Nickel (BKN)	Bombay Gold (BG)	Jewelers Gold (JG)
Europa Bronze (EB)	White (WH)	Sedona Beige (SDB)
Tristan Brass (TB)	Unlacquered Brass (ULB)	Satin Cooper (SCU)

SPECIFICATION DRAWING:

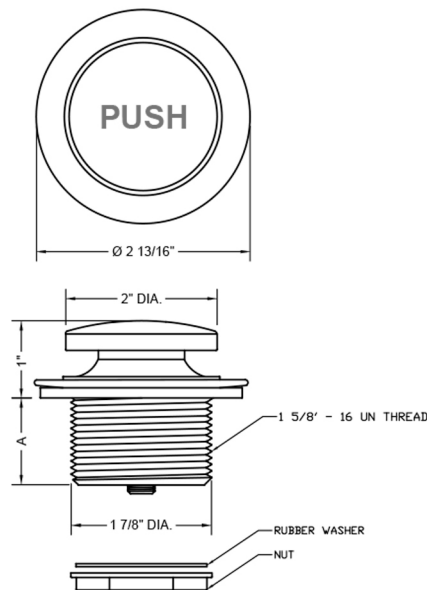

BRASS TO-CONTROL DRAIN STRAINER		
PART. #	DESCRIPTION	A
529-75-	TOE-CONTROL DRAIN STRAINER	3"
529-100-	TOE-CONTROL DRAIN STRAINER	4"
529-125-	TOE-CONTROL DRAIN STRAINER	5"