

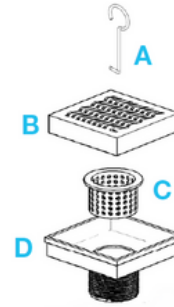

Delmar Series Square Drain

Center Drain | Traditional Waterproofing:

- Stainless Steel 316 Gauges:
Wedge wire grate: 8 gauges for Edge Bars and 9 gauges for Inside Bars.
- Base: 18 gauges = 1.2 mm.
- Grate can be removed completely for cleaning.
- Center Drain is intended for use with traditional waterproofing methods.
- Works with 2" ABS, PVC or Cast Iron shower drain flange (not included).
- Hair strainer basket comes with every drain, fits inside the drain to collect hair and other debris, preventing clogged pipes.



Kit Includes:

- A** Lifting Key
- B** Grate
- C** Hair/Debris Strainer
- D** Base

Specifications

B Grate - Top View 4" X 4"

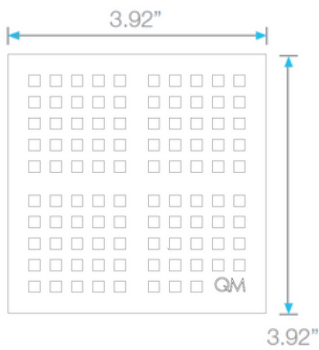

B Grate - Side View



D Base - Top View

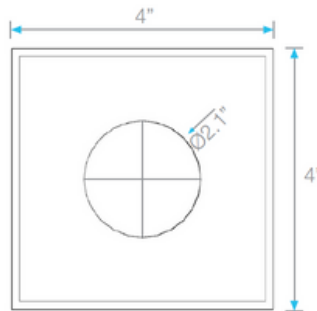

D Base - Side View

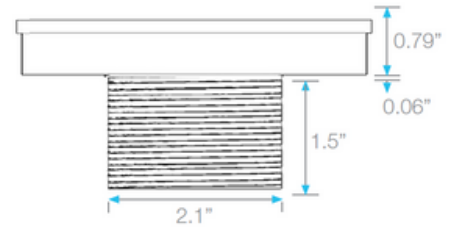

Complete Kits

LOTUS

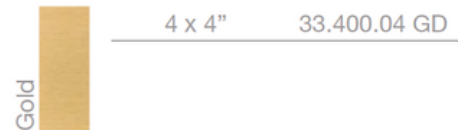
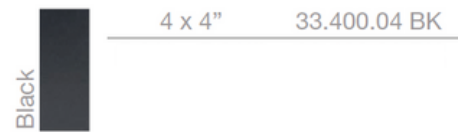
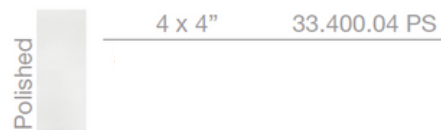
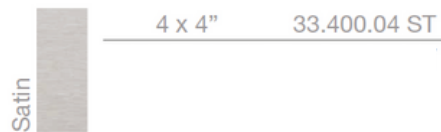
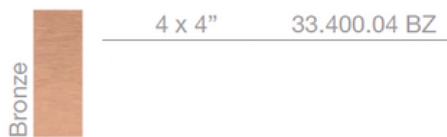

Note: Installer must verify all rough-in dimensions prior to installation and consult local and national codes. Conformity and compliance to local and national codes are the responsibility of the installer. Dimensions are subject to manufacturer's tolerance and change without notice. We can assume no responsibility for use of superseded or voided data. [Contact us if you have any question at: techsupport@qm-us.com](mailto:techsupport@qm-us.com)



DelmarSeries Square Drain

Center Drain | Traditional Waterproofing:

- Stainless Steel 316 Gauges:
Grate: 16 gauges = 1.5 mm.
- Base: 18 gauges = 1.2 mm.
- Grate can be removed completely for cleaning.
- Center Drain is intended for use with traditional waterproofing methods.
- Works with 2" ABS, PVC or Cast Iron shower drain flange (not included).
- Hair strainer basket comes with every drain, fits inside the drain to collect hair and other debris, preventing clogged pipes.

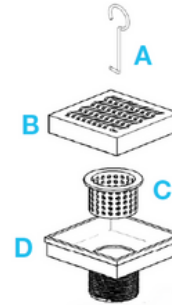

Kit Includes:

- A** Lifting Key
- B** Grate
- C** Hair/Debris Strainer
- D** Base

Specifications

B Grate - Top View 4" X 4"

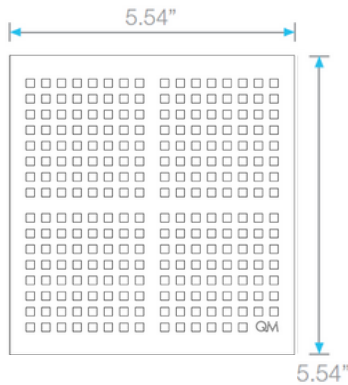

B Grate - Side View



D Base - Top View

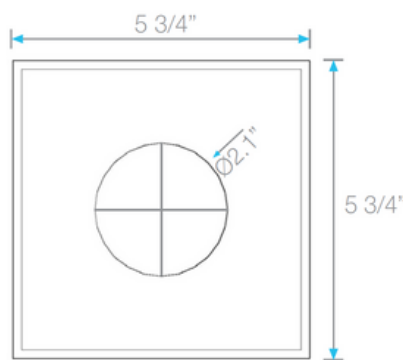

D Base - Side View

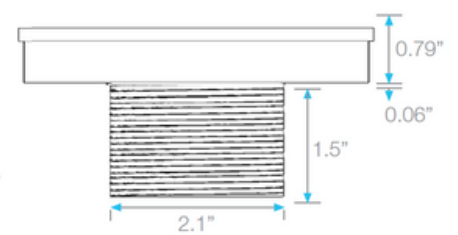

Complete Kits

LOTUS

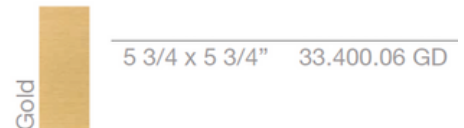
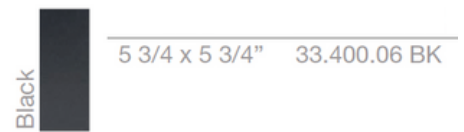
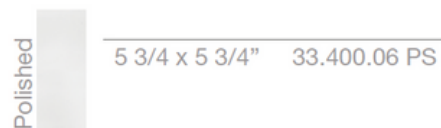
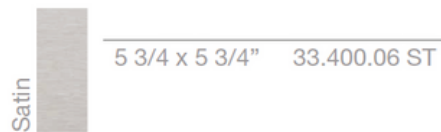
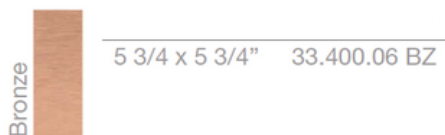

Note: Installer must verify all rough-in dimensions prior to installation and consult local and national codes. Conformity and compliance to local and national codes are the responsibility of the installer. Dimensions are subject to manufacturer's tolerance and change without notice. We can assume no responsibility for use of superseded or voided data. [Contact us if you have any question at: techsupport@qm-us.com](mailto:techsupport@qm-us.com)