

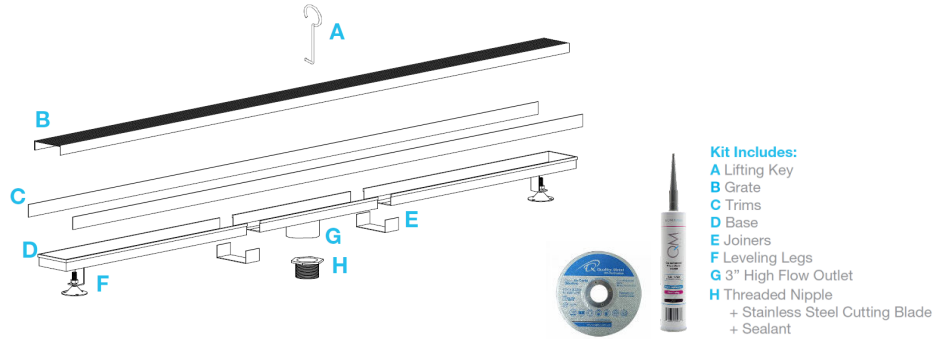

DelmarSeries ADJUSTABLE LINEAR DRAIN 3" HIGH FLOW OUTLET

Adjustable Base | Traditional Waterproofing:

- Stainless Steel Gauges: Grates: 16 gauges
- Base: 18 gauges = 1.2 mm.
- Grate can be removed completely for cleaning.
- Adjustable is intended for use with traditional waterproofing methods.



Specifications

B Grate - Top View



B Grate - Side View

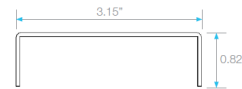

C Trims - Side View

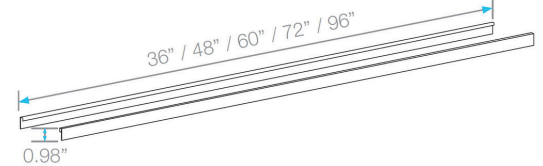

D Base - Side View

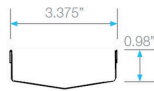

Top View

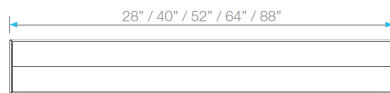

E Joiner - Side & Top View

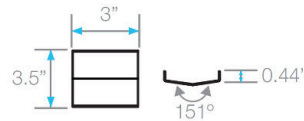

G 3" Outlet - Side & Top View

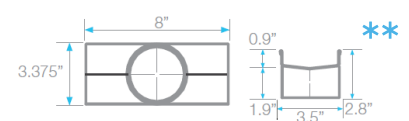

Base End Cap - Side View

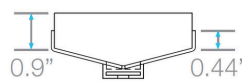

Corner - Top View

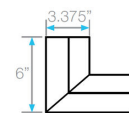

** 72" and *96" Kits include two outlets, two pair of joiners and two adapters.

Complete Kits

PERFORATED



Satin	36"	33.620.36HF ST	●
	48"	33.620.48HF ST	●
	60"	33.620.60HF ST	●
	72"	33.620.72HF ST	●
	96"	33.620.96HF ST	●
Polished	36"	33.620.36HF PS	●
	48"	33.620.48HF PS	●
	60"	33.620.60HF PS	●
	72"	33.620.72HF PS	●
	96"	33.620.96HF PS	●