

CRYSTORAMA

LIGHTING THE WAY FOR SIXTY YEARS

ASSEMBLY INSTRUCTION MODEL#KEN-8303-VG

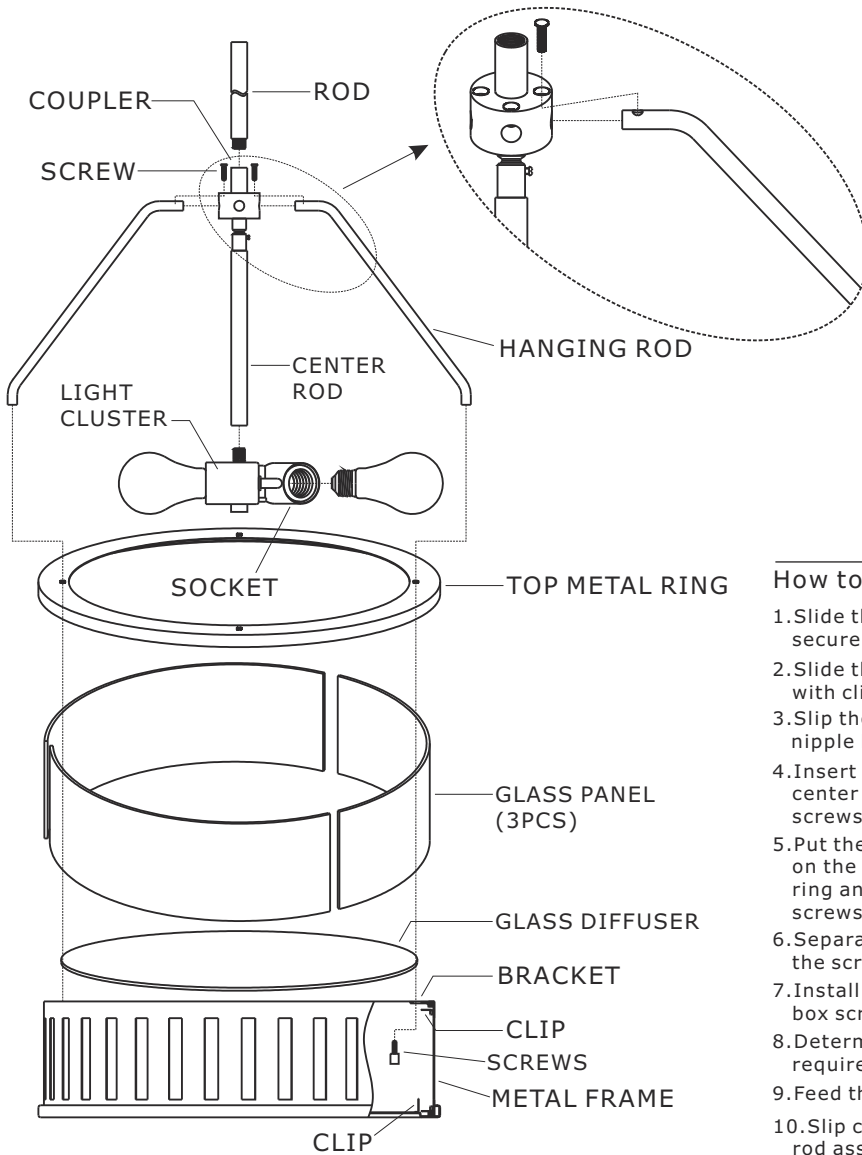

All electrical components must be installed by a licensed electrician in accordance with the National Electric Code and the appropriate local electrical codes.



You will need 3-Medium Base Bulb
60 Watts Recommended 100 Watts Max.
USE LED BULBS FOR EXTENDED USE
This fixture is Damp rated

How to install

1. Slide the glass diffuser onto the bottom of metal frame and secure it with clips.
2. Slide the glass panels inside the metal frame and secure it with clips.
3. Slip the center rod assembly along wire and thread onto the nipple located on the top of the light cluster.
4. Insert the hanging rod into the side holes of top box on the center rod, and secure the hanging rod from the top with the screws.
5. Put the top metal ring over the metal frame. Line up the hole on the bottom of hanging rod with the hole on the top metal ring and the bracket on the metal frame, and secure it with screws.
6. Separate the mounting plate from the canopy kit by removing the screws.
7. Install the mounting plate to the outlet box using two outlet box screws.
8. Determine the preferred hanging height and adjust the required rods.
9. Feed the wires through the rods and connect them together.
10. Slip canopy kit along wire and thread it into the top of the rod assembly.
11. Install canopy onto the mounting plate, and secure with the mounting screws.
12. Install the bulb(not included) into the socket.

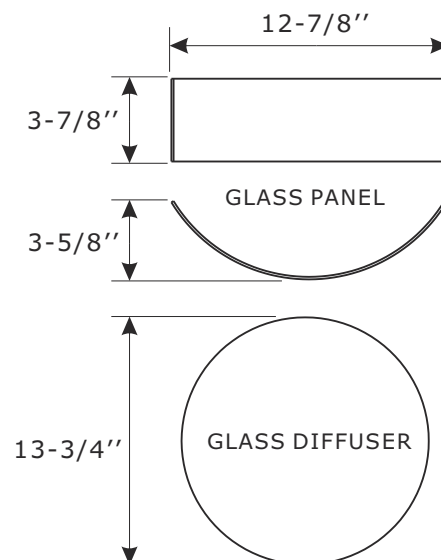
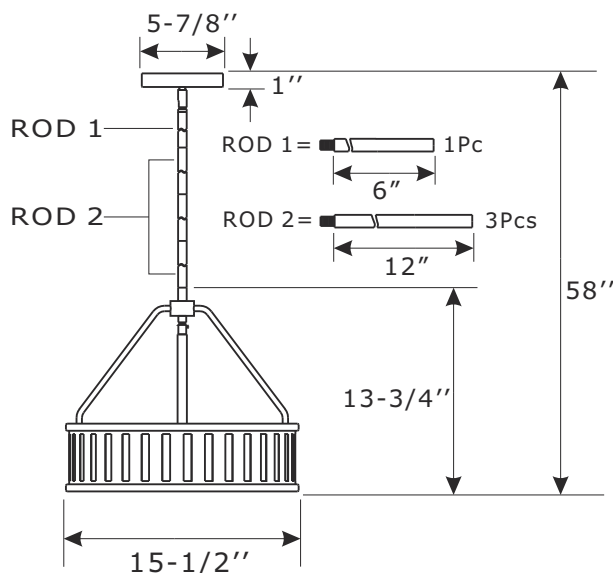

WARNING: This product can expose you to Lead which is known to the state of California to cause cancer and/or birth defects or reproductive harm. For more information go to www.P65Warnings.ca.gov

CRYSTORAMA

LIGHTING THE WAY FOR SIXTY YEARS

ASSEMBLY INSTRUCTION MODEL #KEN-8303-VG

Part Number

Part Numbers

- A. (1)-Mounting hardware
- B. (1)-Mounting plate
- C. (1)-Canopy kit W5-7/8"xH1"#XRF8303VGCAN5.875IN
- D. (2)-Mounting screw
- E. (1)-Rod D5/8"xL6" #XRF8303VGROD6IN
- F. (3)-Rod D5/8"xL12" #XRF8303VGROD12IN
- G. (1)-Coupler
- H. (4)-Screw
- I. (1)-Center rod assembly #XRF8303VGSTEM
- J. (4)-Hanging rod D3/8"xH7-3/4" #XRF8303VGSIDEROD
- K. (1)-Light cluster
- L. (1)-Top metal ring
- M. (3)-Glass panel
- N. (1)-Glass diffuser #XRF8303DIFF13.75IN
- O. (1)-Metal frame
- P. (4)-Screw

