

# CRYSTORAMA

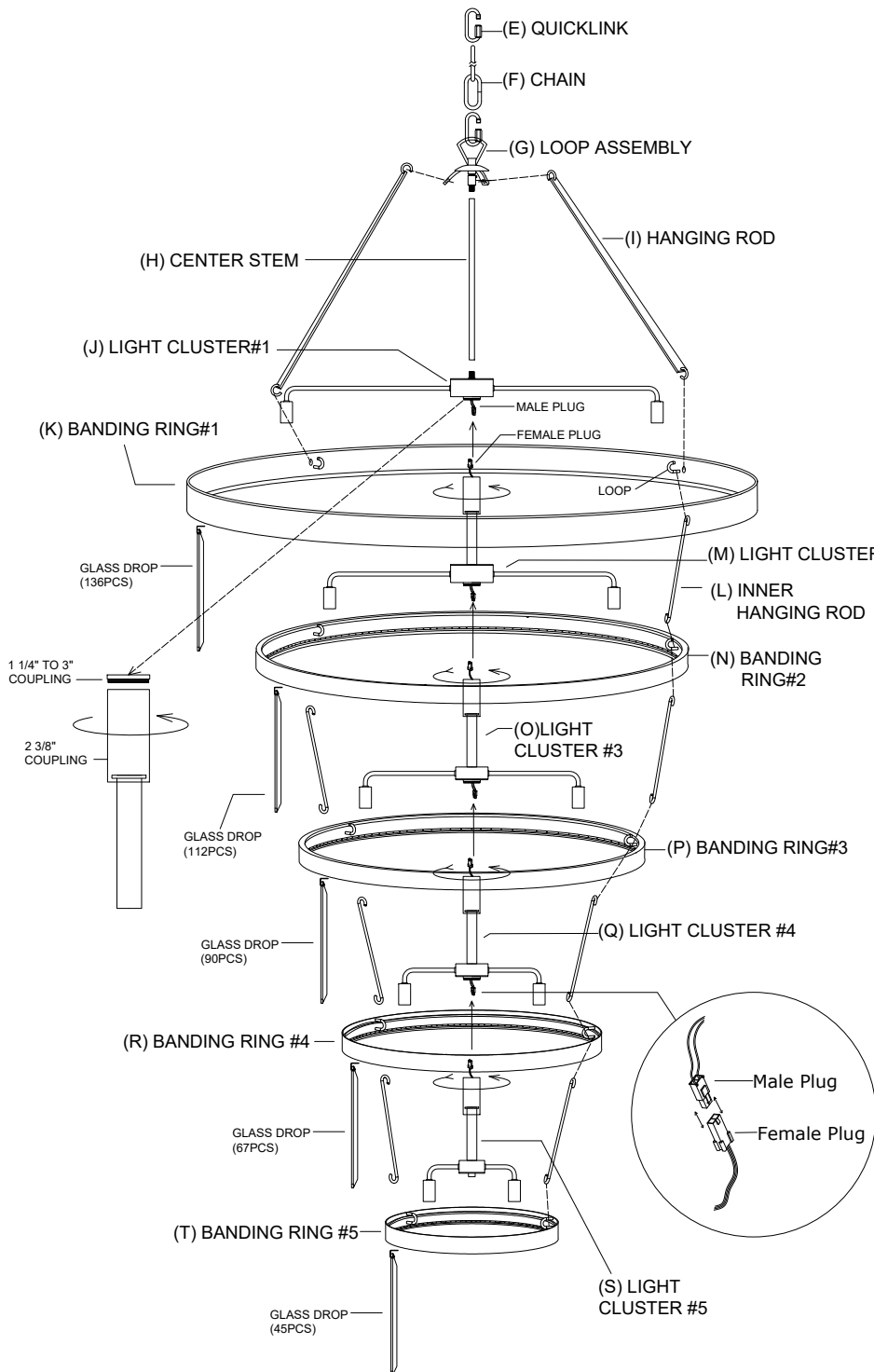

LIGHTING THE WAY FOR SIXTY YEARS

## ASSEMBLY INSTRUCTION MODEL #EMO-5430-BK



### WARNING:



Electrical Danger



Turn Power Off

All electrical components must be installed by a licensed electrician in accordance with the National Electric Code and the appropriate local electrical codes.

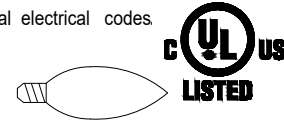

You will need 30- Candelabra Base Bulb  
40 Watts recommended 60 Watts Max.  
USE LED BULBS FOR EXTENDED USE.

The fixture is Damp rated.

### HOW TO INSTALL:

Place the fixture parts on a soft cloth-covered platform before installation of fixture.

1. Slip the center stem along wire and thread onto the screw on the top of the light cluster #1.
2. Slip the loop assembly along wire and thread into the center stem.
3. Connect the male plug of light cluster #1 with the female plug of light cluster #2, then assemble the 2 3/8" coupling of light cluster #2 with the 1 1/4" to 3" coupling of light cluster #1.
4. Repeat the process of step 3 to assemble light cluster #2 through light cluster #5.
5. Hang the hanging rod from the loop of banding ring #1, with the other end hanging on the loop assembly.
6. Hang the inner hanging rods from the loop of banding ring #1, with the other end hanging on the loop of banding ring #2.
7. Repeat the process of step 6 to assemble banding ring #2 through banding ring #5.
8. Install bulbs (not included) into the socket.
9. Hang glass drop to the banding ring.

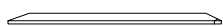

450 Sets. (1) W1" x L7 8/7" GLASS DROP

**WARNING:** This product can expose you to Lead, which is known to the State of California to cause cancer and/or birth defects or reproductive harm. For more information go to [www.p65warnings.ca.gov](http://www.p65warnings.ca.gov)

# CRYSTORAMA



LIGHTING THE WAY FOR SIXTY YEARS

## ASSEMBLY INSTRUCTION MODEL #EMO-5430-BK

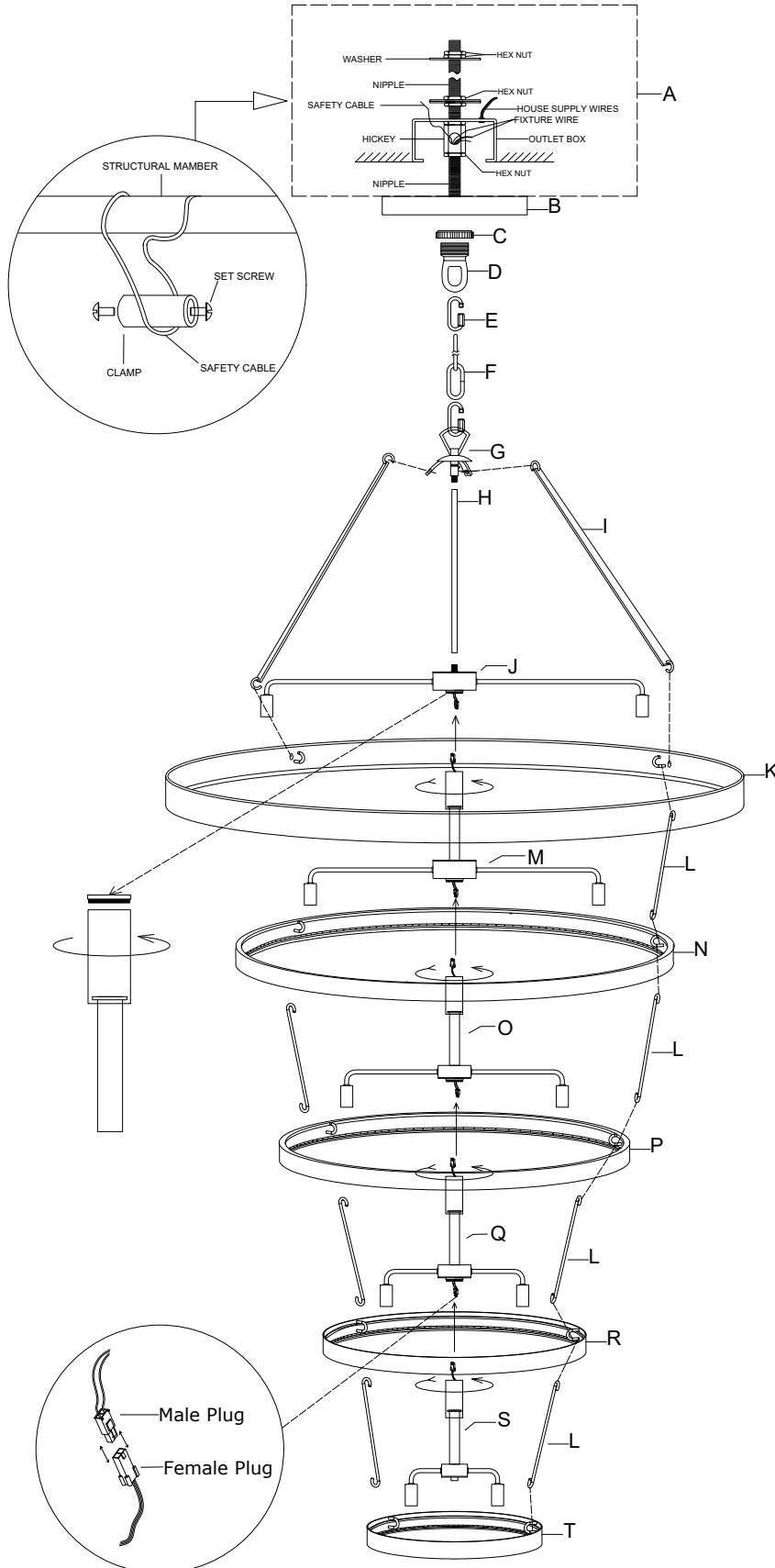

## Part Number

### Part Numbers

- A. (1)-Mounting hardware
  - Washer x4.
  - Nipple x2.
  - Hex Nut x5.
  - Hickey x1.
  - Safety Cable x1.
  - Clamp x1.
  - Set Screw x2.
  - Wire connector x2.
- B. (1)-Canopy (W6"xH1")-XSN5430BKCAN6IN
- C. (1)-Collar ring
- D. (1)-Collar loop-XSN5430BKLOOP
- E. (2)-Quicklink
- F. (1)-Chain (5.5mmx72")-XSN5430BKCHA5.5MM
- G. (1)-Loop assembly
  - Hanging bracket.
  - Swivel.
  - Thread nipple.
- H. (1)-Center stem ; H24 3/8"-XSN5430BKSTEM24.375IN
- I. (3)-Hanging rod ; H33 1/2"-XSN5430BKHROD33.5IN
- J. (1)-Light cluster #1
  - Screw.
  - Distributor box ; Ø4"
  - 15 3/4" Arm with socket x8.
  - 1 1/4" to 3" coupling.
  - Male plug.
- K. (1)-Banding ring #1
  - Ø47 3/4" x H1 1/2" banding ring with 136 holes ; Loop x3.
  - XSN5430BKRING1
- L. (12)-9"Inner hanging rod-XSN5430BKINROD9IN
- M. (1)-Light cluster #2
  - Female plug.
  - 2 3/8" Coupling.
  - 4 3/8" Threaded pipe.
  - Distributor box ; Ø4"
  - 11 3/4" Arm with socket x8.
  - 1 1/4" to 3" coupling.
  - Male plug.
- N. (1)-Banding ring #2
  - Ø41 3/8" x H1 1/2" banding ring with 112 holes ; Loop x3.
  - XSN5430BKRING2
- O. (1)-Light cluster #3
  - Female plug.
  - 2 3/8" Coupling.
  - 4 3/8" Threaded pipe.
  - Distributor box ; Ø3 1/8"
  - 9" Arm with socket x6.
  - 1 1/4" to 3" coupling.
  - Male plug.
- P. (1)-Banding ring #3
  - Ø31 7/8" x H1 1/2" banding ring with 90 holes ; Loop x3.
  - XSN5430BKRING3
- Q. (1)-Light cluster #4
  - Female plug.
  - 2 3/8" Coupling.
  - 4 3/8" Threaded pipe.
  - Distributor box ; Ø3 1/8"
  - 5 1/2" Arm with socket x4.
  - 1 1/4" to 3" coupling.
  - Male plug.
- R. (1)-Banding ring #4
  - Ø24" x H1 1/2" banding ring with 67 holes ; Loop x3.
  - XSN5430BKRING4
- S. (1)-Light cluster #5
  - Female plug.
  - 2 3/8" Coupling.
  - 4 3/8" Threaded pipe.
  - Distributor box ; Ø2 3/8"
  - 2 3/4" Arm with socket x4.
  - 1 1/4" to 3" coupling.
  - Finial.
- T. (1)-Banding ring #5
  - Ø15 3/4" x H1 1/2" banding ring with 45 holes ; Loop x3.
  - XSN5430BKRING5

# CRYSTORAMA



LIGHTING THE WAY FOR SIXTY YEARS

## ASSEMBLY INSTRUCTION MODEL #EMO-5430-BK

### SAFETY CABLE INSTALLATION INSTRUCTIONS

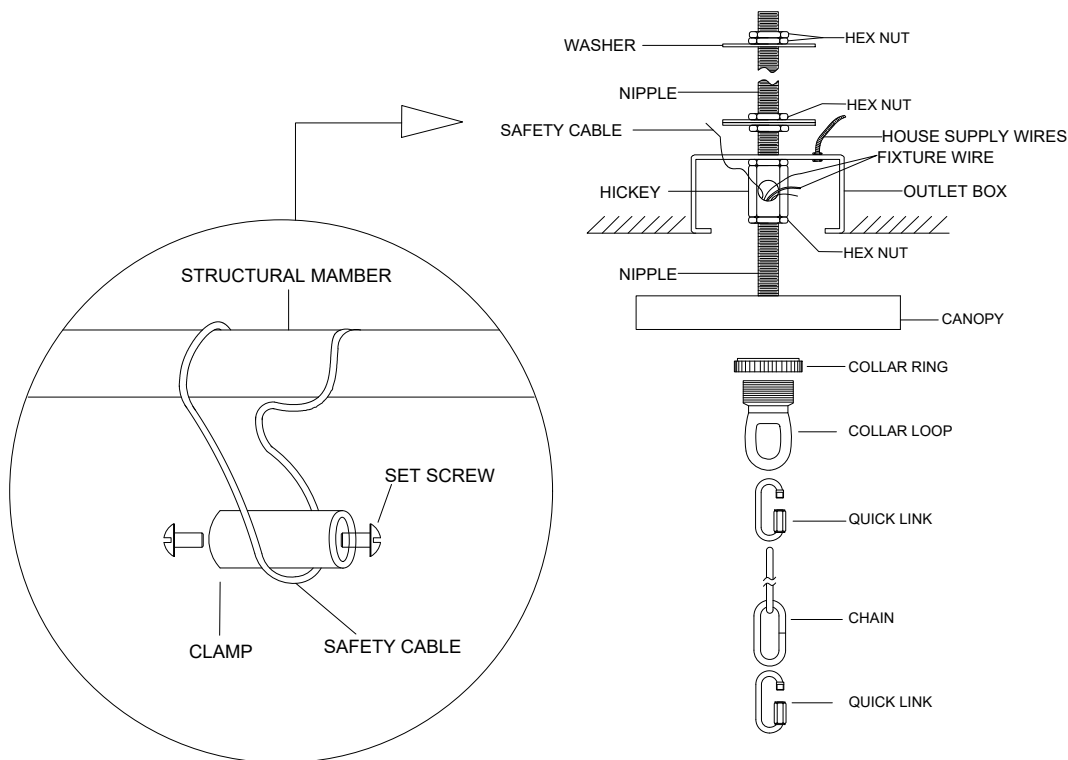

#### IMPORTANT:

FOR A SAFE AND SECURE INSTALLATION, THESE FIXTURES MUST BE INSTALLED BY MEANS OF SUPPORTS THAT ARE INDEPENDENT OF THE OUTLET BOX.

#### SUGGESTED INSTALLATION:

1. Provide a 1/4 IPS pipe with one end securely mounted to a beam or a structural member.  
The other end should protrude through the center of the outlet, as shown.
2. Assemble the screw collar loop, nipple, hex nuts and hickey to center 1/4 IPS support pipe and adjust overall length to allow the collar ring to hold the canopy flush to the ceiling.  
When the adjustments have been completed secure the hex nut, as shown.
3. Use one quick link to connect fixture loop and the bottom of chain. Slide the screw collar ring over the upper end of the chain, through the (Finished side down).  
Then use another quick link to connect collar loop and the top of chain.
4. Lace the fixture wires, ground wires and safety cable through the chain and screw collar loop, exiting through the side of HICKEY.  
Proceed to attach the FIXTURE GROUND WIRE to HOUSE GROUND WIRE using wire connector.  
Using wire connectors, connect the HOUSE WHITE WIRE to the FIXTURE SUPPLY WIRE (WHITE OR RIBBED SIDE) ; connect the HOUSE BLACK (or RED) WIRE to the FIXTURE SUPPLY WIRE (BLACK or SMOOTH SIDE).  
Wrap all connectors with approved electrical tape.  
Wrap safety cable around outlet box brace and pull cable taut.  
Secure cable with the clamp and (2) set screws provided, as shown.
5. Push the CANOPY upward over the OUTLET BOX. Be sure that all wires are carefully tucked into the OUTLET BOX cavity.  
Secure canopy against ceiling by threading CANOPY LOCK RING onto the CANOPY LOOP. Tighten until snug.

# CRYSTORAMA



Crystorama.com

LIGHTING THE WAY FOR SIXTY YEARS

## ASSEMBLY INSTRUCTION MODEL #EMO-5430-BK

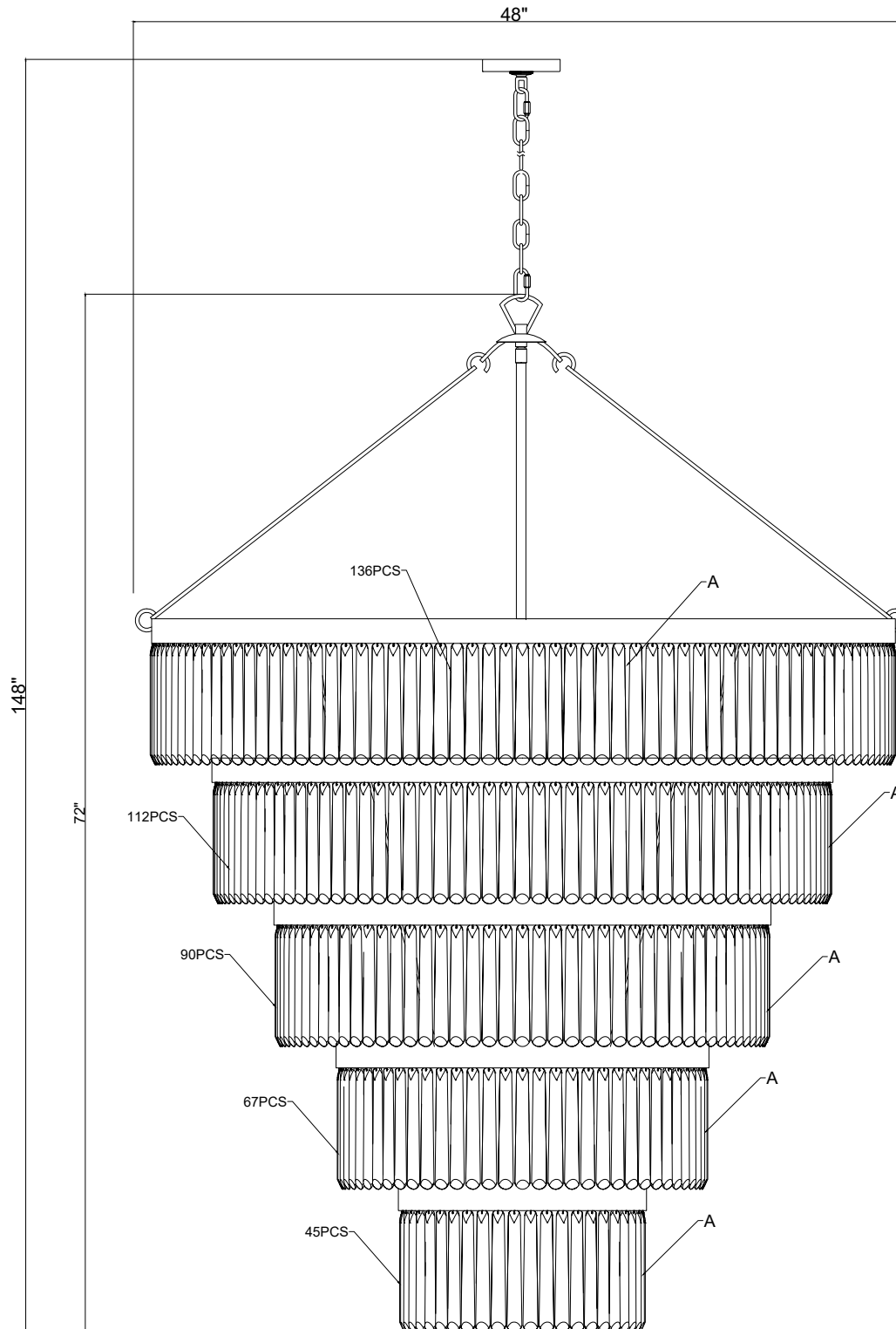

### Crystal Sets

 A. 450 Sets. (1) W1" x L7 8/7" GLASS DROP