

ASSEMBLY INSTRUCTION MODEL #ED3551801CH

Caution: when installing fixture, gloves must be worn to prevent scratches.

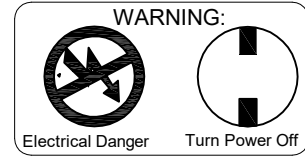

All electrical components must be installed by a licensed electrician in accordance with the National Electric Code and the appropriate local electrical codes.

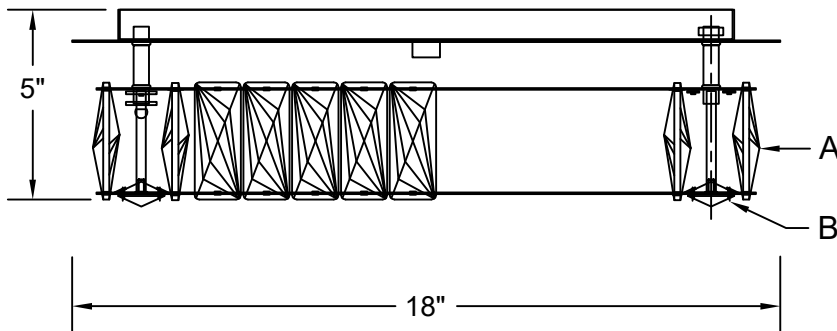

Fixture uses Integrated LEDs (Included) 27 Watts Max.

DETAILED ILLUSTRATION

A

B

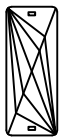

The fixture is dry rated

How to Install

1. Attach the mounting plate onto the outlet box using two outlet screws.
2. Secure the fixture up to the ceiling and do the wire connections. Secure canopy with the hex nut, check ring and the finial.

How to replace the crystal

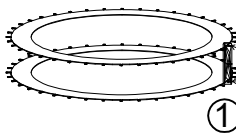

Using the included plier, grip both protruding pins at once and bend the pins together until they are straight.

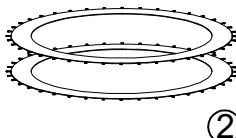

Remove the broken crystal from the frame.

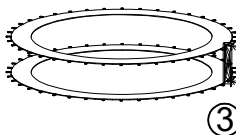

Align the holes of the new crystal with the pins on the fixture, then push the crystal in until the pins are protruding through the holes. Using the included plier, grip each pin individually and bend outward, away from the other pin, until the crystal is secure.

Crystal Sets

- A. 72Sets. (1)30x76mm
- B. 30Sets. (1)30x30mm

WARNING: This product can expose you to Lead, which is known to the State of California to cause cancer and/or birth defects or reproductive harm. For more information go to www.P65Warnings.ca.gov

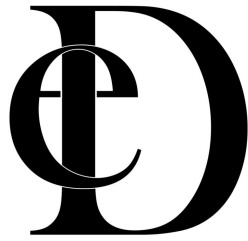

PART NUMBER MODEL #ED3551801CH

Part Number

Part Numbers

- A. (2)-Wire Connector
- B. (1)-Mounting Plate
- C. (2)-Outlet Box Screws
- D. (1)-Ground Wire
- E. (1)-Frame
- F. (1)-Washer
- G. (1)-Nut
- H. (1)-Check Ring
- I. (1)-Finial (XFB3541801CHFIN)

PART BAG I : Includes Parts A,C

