

ASSEMBLY INSTRUCTION MODEL #3542401CH

Caution: when installing fixture, gloves must be worn to prevent scratches.

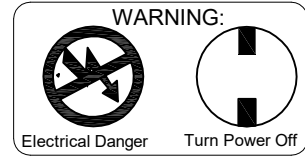

All electrical components must be installed by a licensed electrician in accordance with the National Electric Code and the appropriate local electrical codes.



Fixture uses Integrated LEDs (Included) 36 Watts Max.

The fixture is dry rated

How to Install

1. Attach the mounting plate onto the outlet box using two outlet screws.
2. Secure the fixture up to the ceiling and do the wire connections. Secure canopy with the hex nut, check ring and the finial.

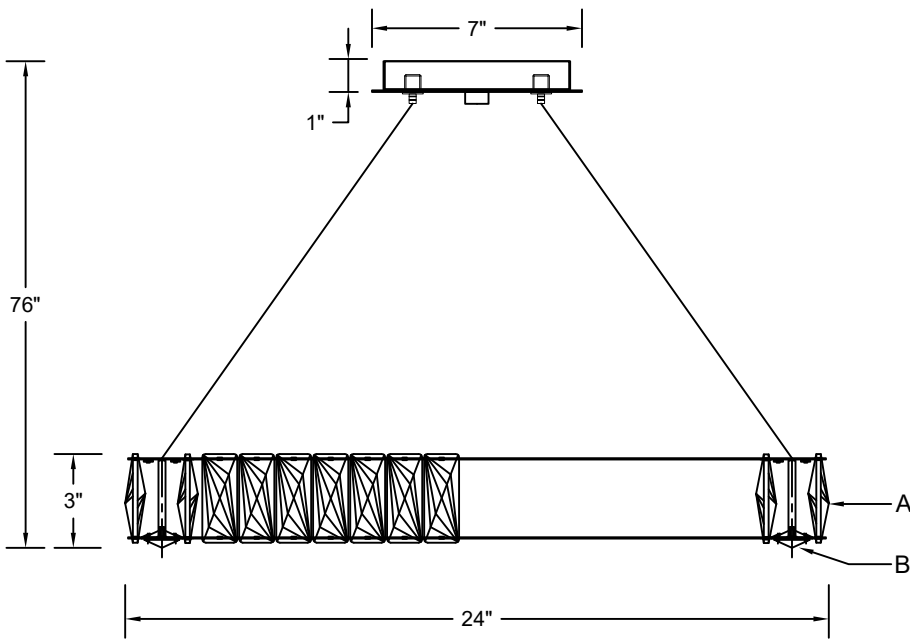

DETAILED ILLUSTRATION

A



B



Crystal Sets

- A. 108Sets. (1)30x76mm
- B. 40Sets. (1)30x30mm

How to replace the crystal

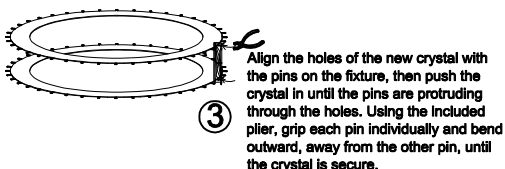
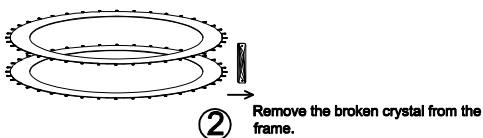
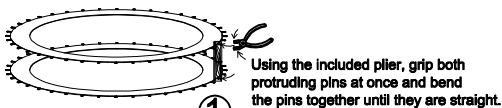

How to adjust the length of the cable wire

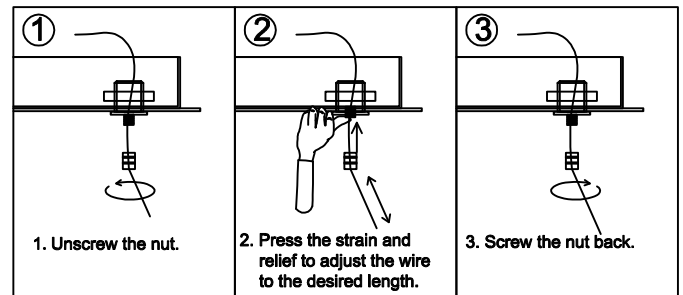

WARNING: This product can expose you to Lead, which is known to the State of California to cause cancer and/or birth defects or reproductive harm. For more information go to www.P65Warnings.ca.gov

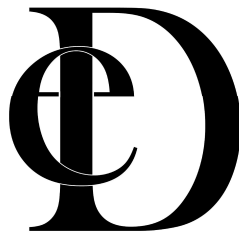

PART NUMBER MODEL #ED3542401CH

Part Number

Part Numbers

- A. (2)-Wire Connector
- B. (1)-Mounting Plate
- C. (2)-Outlet Box Screws
- D. (1)-Ground Wire
- E. (1)-Canopy; w7" x h1" (XFB3541801CHCAN7IN)
- F. (4)-Cable Wire
- G. (1)-Frame
- H. (1)-Washer
- I. (1)-Nut
- J. (1)-Check Ring
- K. (1)-Finial (XFB3541801CHFIN)

PART BAG I : Includes Parts A,C

