

CRYSTORAMA



Crystorama.com



LIGHTING THE WAY FOR SIXTY YEARS

ASSEMBLY INSTRUCTION MODEL #CLO-8890-AG

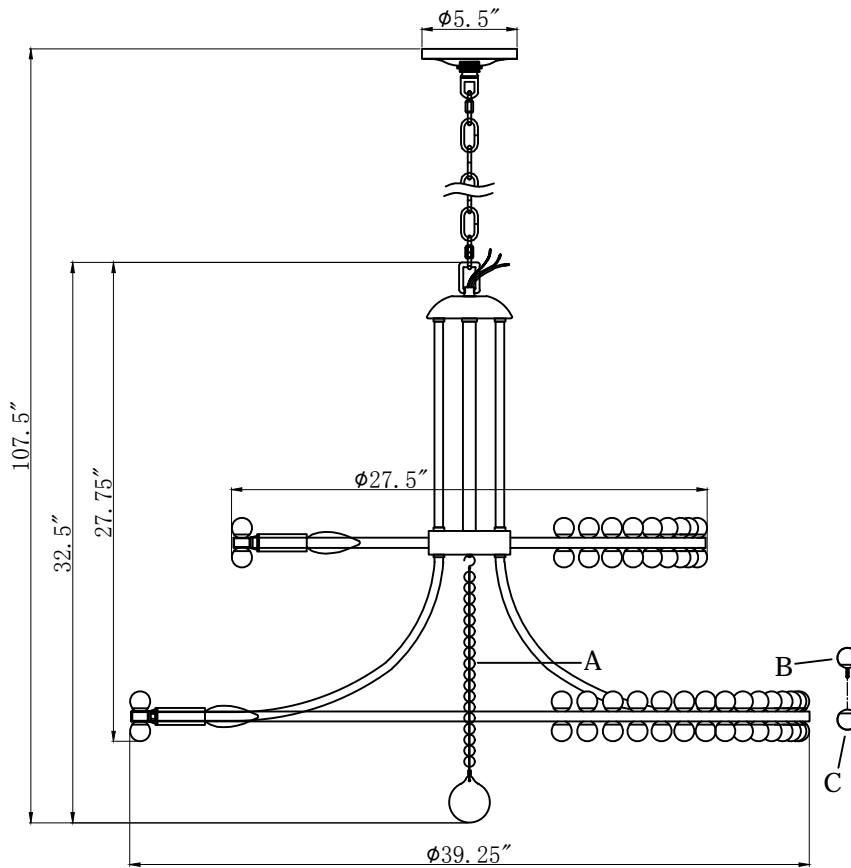
Drawing (1)

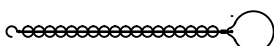

CRYSTAL SETS:

- A=  $\emptyset 16\text{mm} \times 19 + \emptyset 60\text{mm} \times 1$
- B=  $\emptyset 30\text{mm} \times 120$, Crystal ball with long thread
- C=  $\emptyset 30\text{mm} \times 120$, Crystal ball

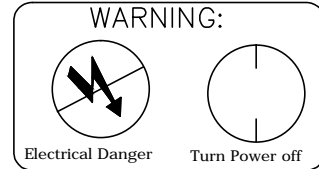

All electrical components must be installed by a licensed electrician in accordance with the National Electric Code and the appropriate local electrical codes.



You will need 24-Candelabra BULB
40 watts Max Bulb not included
USE LED BULBS FOR EXTENDED USE
THIS FIXTURE IS DRY RATED

How to install :

1. Put the check ring over the hex nut on top of wiring box.
2. Screw the lower rod and center stem onto the top of wiring box.
3. Slide the center ring over the lower rods and center stem and secure the center ring with hex nut and check ring.
4. Screw the upper rods onto the center.
5. Place the top metal plate over the upper rods and secure it with hex nuts.
6. Pull the wire from center stem through the hickey until taut and put the top cap over it and secure with fixture loop.
7. Insert each long threaded crystal ball through the bottom of the ring, then secure it from the top with the crystal ball (without nipple).

How to install :

1. Place the upper rod kit over the distributor box on the top of the upper ring and plug the wires together.
2. Secure the upper rod kit onto the distributor box using the screws and wrench provided.
3. Put the crystal strand in the center of the fixture.
4. Screw the crystal balls onto the frame as illustrated.
5. Refer to the next page for safety cable installation.

 **WARNING:** This product can expose you to Lead which is known to the state of California to cause cancer and/or birth defects or reproductive harm. For more information go to www.P65Warnings.ca.gov

CRYST RAMA



Crystorama.com

LIGHTING THE WAY FOR SIXTY YEARS

PART NUMBER MODEL #CLO-8890-AG

Part Number

Part Numbers

- A. Mounting Hardware
- (3) Wire Nut
- (1) Hickey
- (2) 1/4" IP threaded pipe
- (4) Nut
- (2) 2" Flat Washer
- (4) Spring Washer
- B. (1) Canopy; Ø5.5"x0.98"h; XME8000AGCAN5.5IN
- C. (2) Quick Link
- D. (1) Chain; 72"Lx Ø5.0mmT; XME8890AGCHA5.0MM
- E. (1) Top Loop
- F. (1) Upper rod kit
- G. (4) Screw
- H. (1) Allen wrench
- I. (1) Upper Metal ring
- J. (4) Arm; Ø1/2"
- K. (1) Lower Metal ring
- L. (24) Candle Sleeve; Ø1"x2.8"h; XME8000AGCDL2.8IN
- M. (1) Strand Crystal

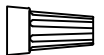
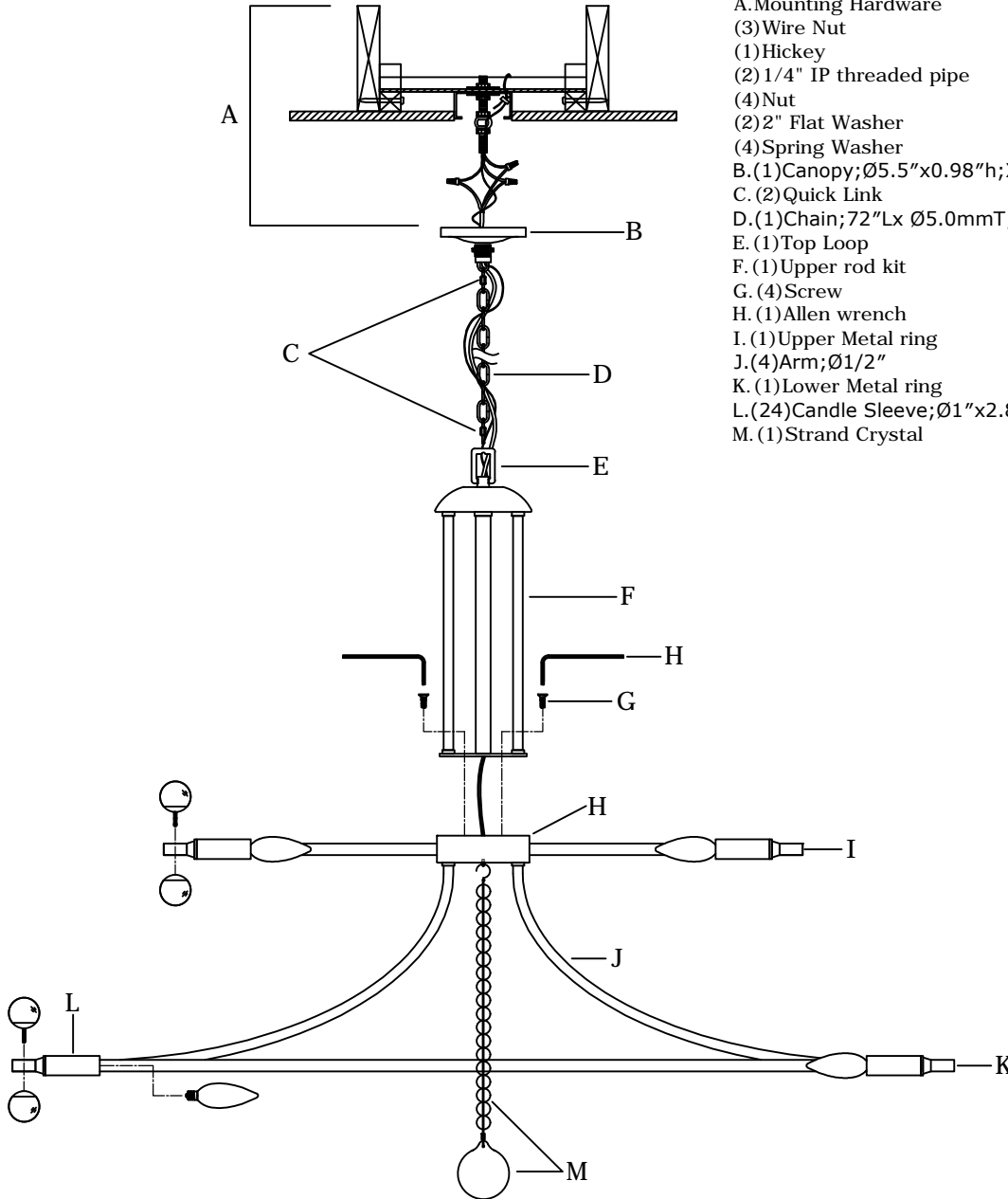

x3

Wire Nut

CRYSTORAMA

LIGHTING THE WAY FOR SIXTY YEARS



PART NUMBER MODEL #CLO-8890-AG

SAFETY CABLE INSTALLATION INSTRUCTIONS

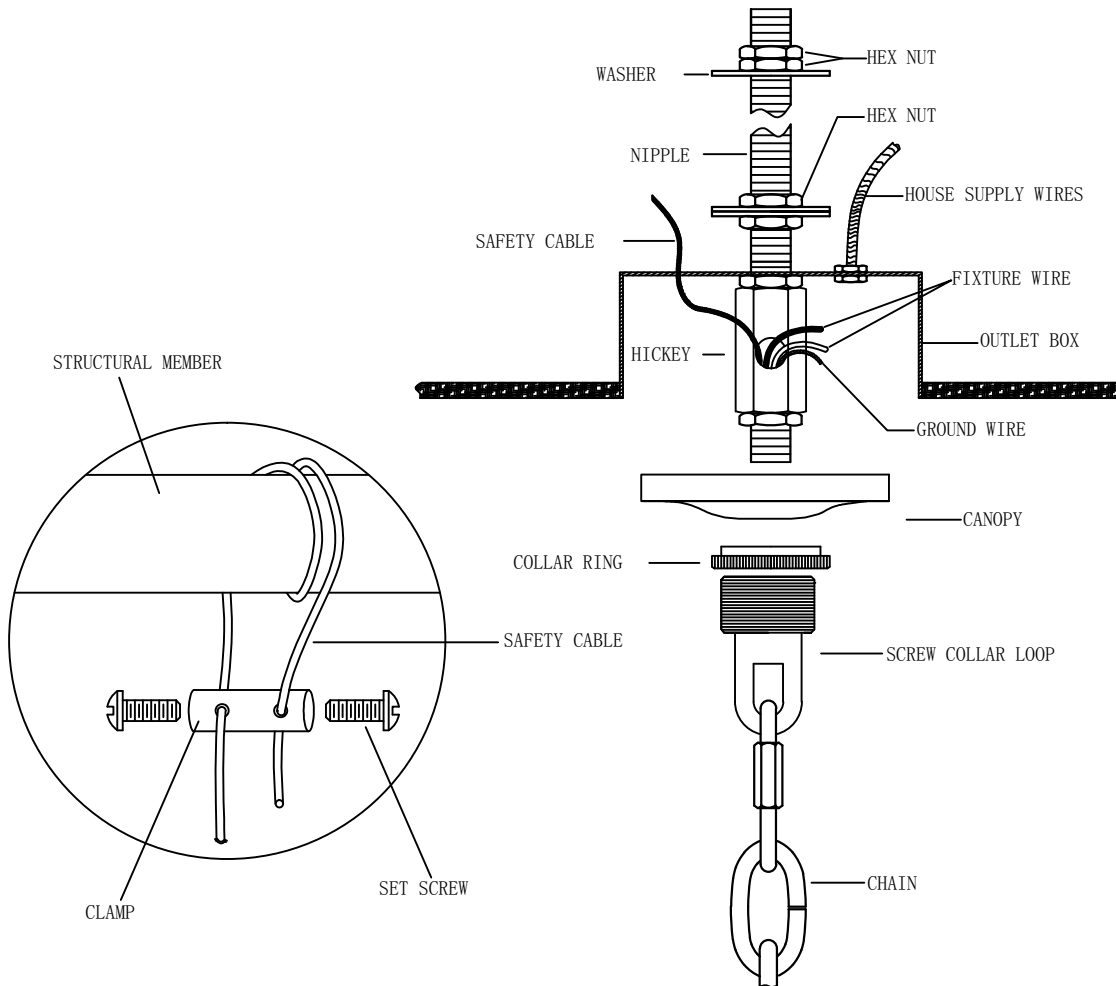

IMPORTANT:

FOR A SAFE AND SECURE INSTALLATION, THESE FIXTURES MUST BE INSTALLED BY MEANS OF SUPPORTS THAT ARE INDEPENDENT OF THE OUTLET BOX.

SUGGESTED INSTALLATION:

1. Start with 1/4 IPS on one end securely mounted to a beam or a structural member. The other end should protrude through the center of the outlet, as shown.
2. Assemble the screw collar loop, nipple, hex nuts and hickey to center 1/4 IPS support pipe and adjust overall length to allow the collar ring to hold the canopy flush to the ceiling. When the adjustments have been completed, Secure the hex nut, as shown.
3. Attach the chain to the fixture loop. Slide the screw collar ring over the upper end of the chain, through the canopy (Finished side down). Open the end link of chain and lift the fixture to attach to the screw collar loop and secure the link.
4. Lace the fixture wires, ground wires and safety cable through the chain and screw collar loop, exiting through the side of hickey. Proceed to attach the fixture ground wire to house ground wire using wire connector. Using wire connectors, connect the house white wire to the fixture supply wire (white or ribbed side); connect the house black (or red) wire to the fixture supply wire (black or smooth side). Wrap all connectors with approved electrical tape. Wrap safety cable around outlet box brace and pull cable taut. Secure cable with the clamp and (2) set screws provided, as shown.
5. Push the CANOPY upward over the OUTLET BOX. Be sure that all wires are carefully tucked into the OUTLET BOX cavity. Secure canopy against ceiling by threading CANOPY LOCK RING onto the CANOPY LOOP. Tighten until snug.