

CRYSTORAMA

LIGHTING THE WAY FOR SIXTY YEARS



Crystorama.com

ASSEMBLY INSTRUCTION MODEL #9224-OS

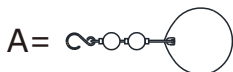
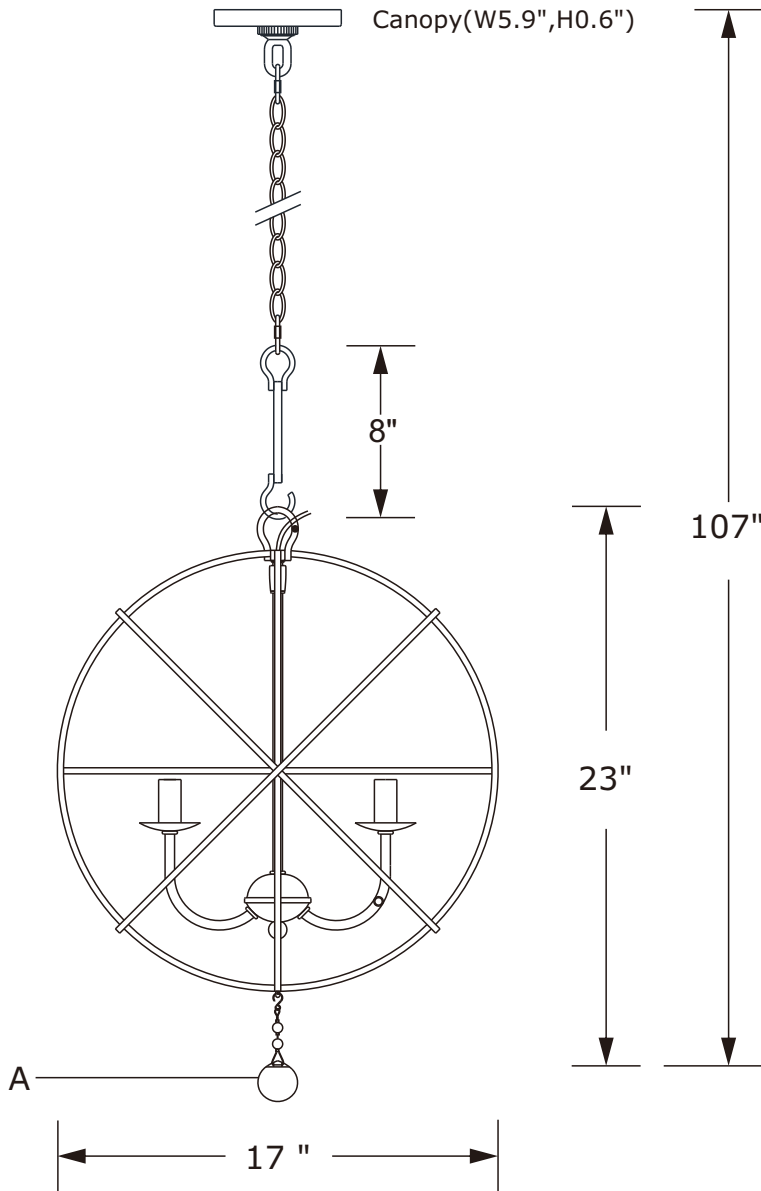

2XØ10mm+1XØ40mmBall



All electrical components must be installed by a licensed electrician in accordance with the National Electric Code and the appropriate local electrical codes.



You will need 5 -Candelabra Base Bulb
40 Watts Recommended 60 Watts Max.
USE LED BULBS FOR EXTENDED USE
THIS FIXTURE IS DAMP RATED

How to Install

1. Do a complete inventory of all parts and components before you start installation.
2. Install bulbs (not included).
3. Install the mounting plate onto outlet box and secure it with the outlet box screws.
4. Take the end of the rod with a hook and attach it to the top of the fixture frame. Open a quick link and attach it to the other end of the rod (the end with a closed loop).
5. Thread the collar ring into the canopy.
6. Open the other quick link and attach it to the collar loop.
7. Connect fixture wires into the outlet box.
8. Raise the canopy onto the collar loop and secure it with the collar ring.
9. Attach the crystal ball "A" on the bottom of fixture.
10. After safely attaching fixture into outlet box, proceed to connecting the power.

WARNING: This product can expose you to Lead, which is known to the State of California to cause cancer and/or birth defects or reproductive harm. For more information go to www.P65Warnings.ca.gov.

CRYSTORAMA

LIGHTING THE WAY FOR SIXTY YEARS



Crystorama.com

PART NUMBER MODEL # 9224-OS

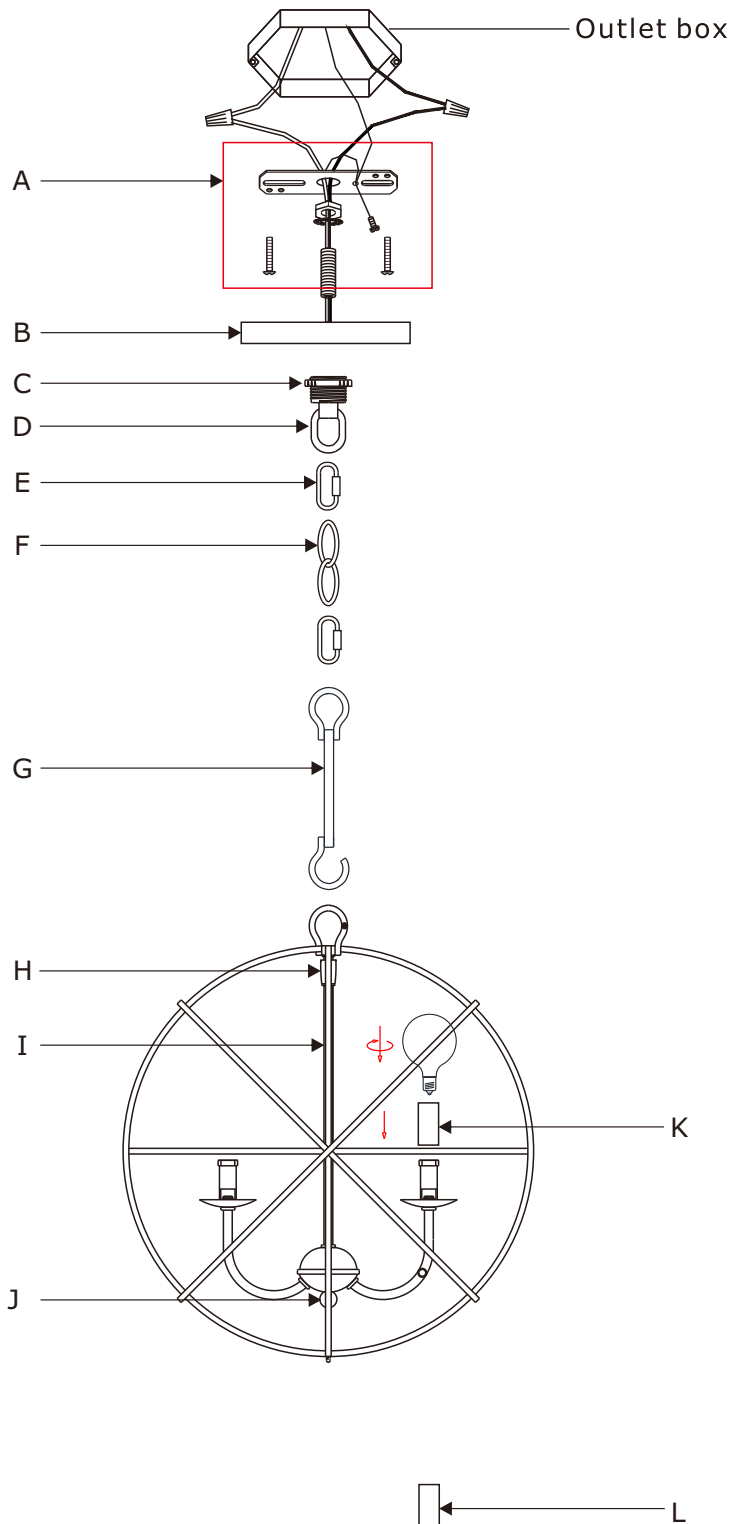

Part Number

- A.(1) - Mounting Hardware
- B.(1) - Canopy(W5.9", H0.6") #XRE9224OSCAN5.9IN
- C.(1) - Collar Ring
- D.(1) - Collar Loop
- E.(2) - Quick Link
- F.(1) - Hanging Chain(72",4mm) #XRE9220OSCHA4MM
- G.(1) - Rod(8",9.3mm) #XRE9224OSROD8IN
- H.(1) - Swivel
- I.(1) - Center Stem(10.83",9.3mm) #XRE9224OSSTEM10.83IN
- J.(1) - Final #XRE9224OSFIN
- K.(5) - Candle Sleeve(W0.87",H1.97") #XRE9224OSCDL1.97IN
- L.(5) - White Plastic Candle Sleeve (W0.87",H1.97") #XRE9224PCDL1.97IN