

CRYSTORAMA

LIGHTING THE WAY FOR SIXTY YEARS

ASSEMBLY INSTRUCTION MODEL #6623-MK-CL-MWP_CEILING

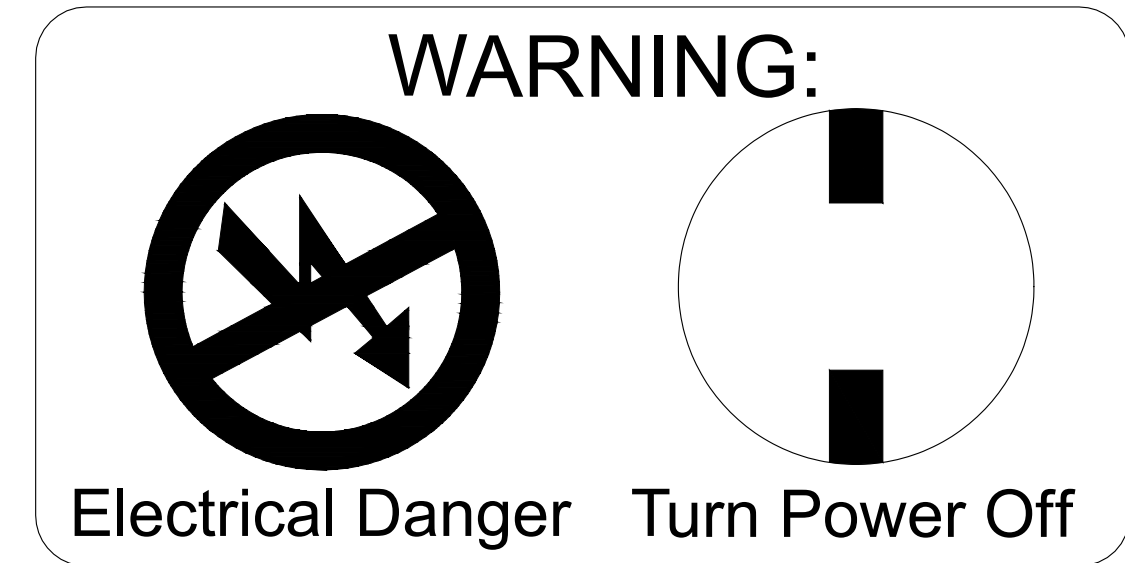
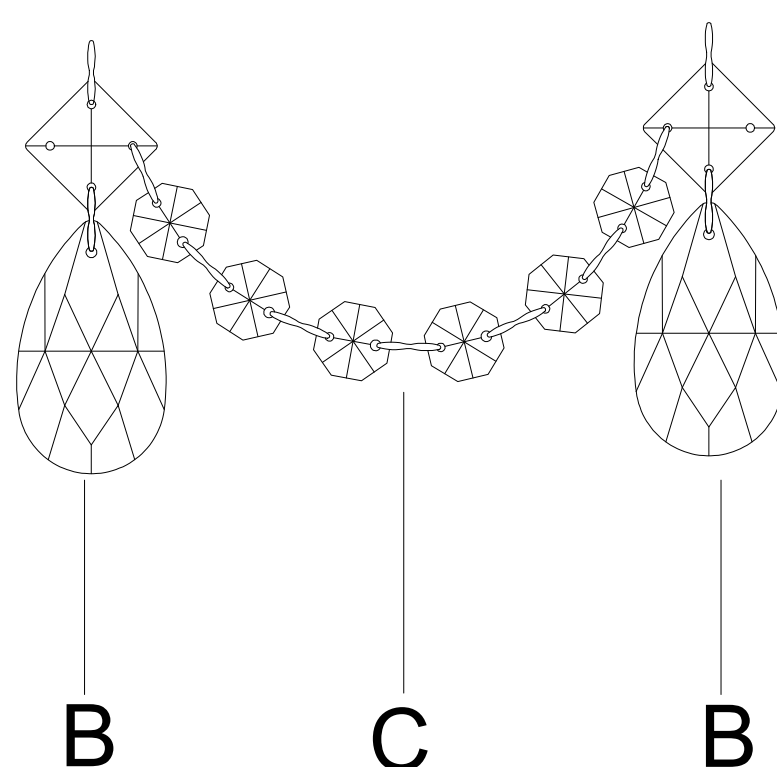
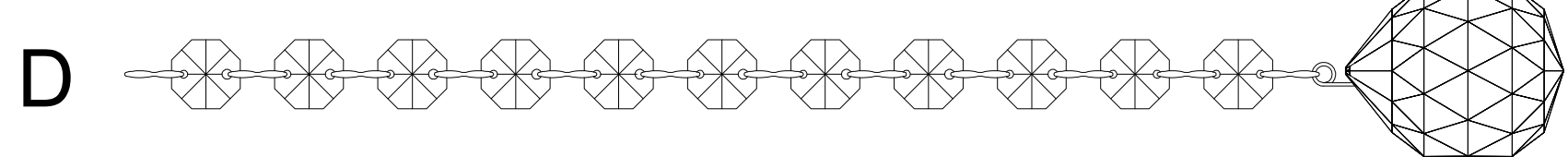
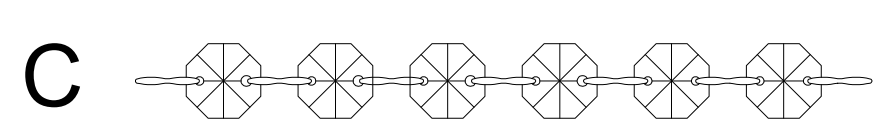
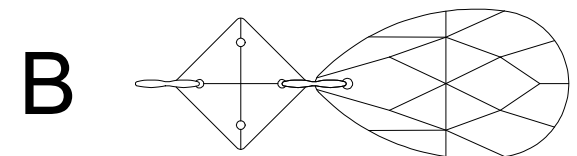
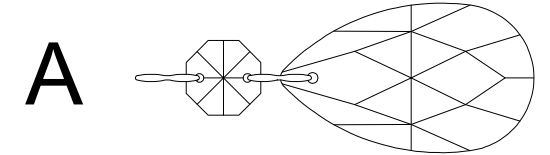
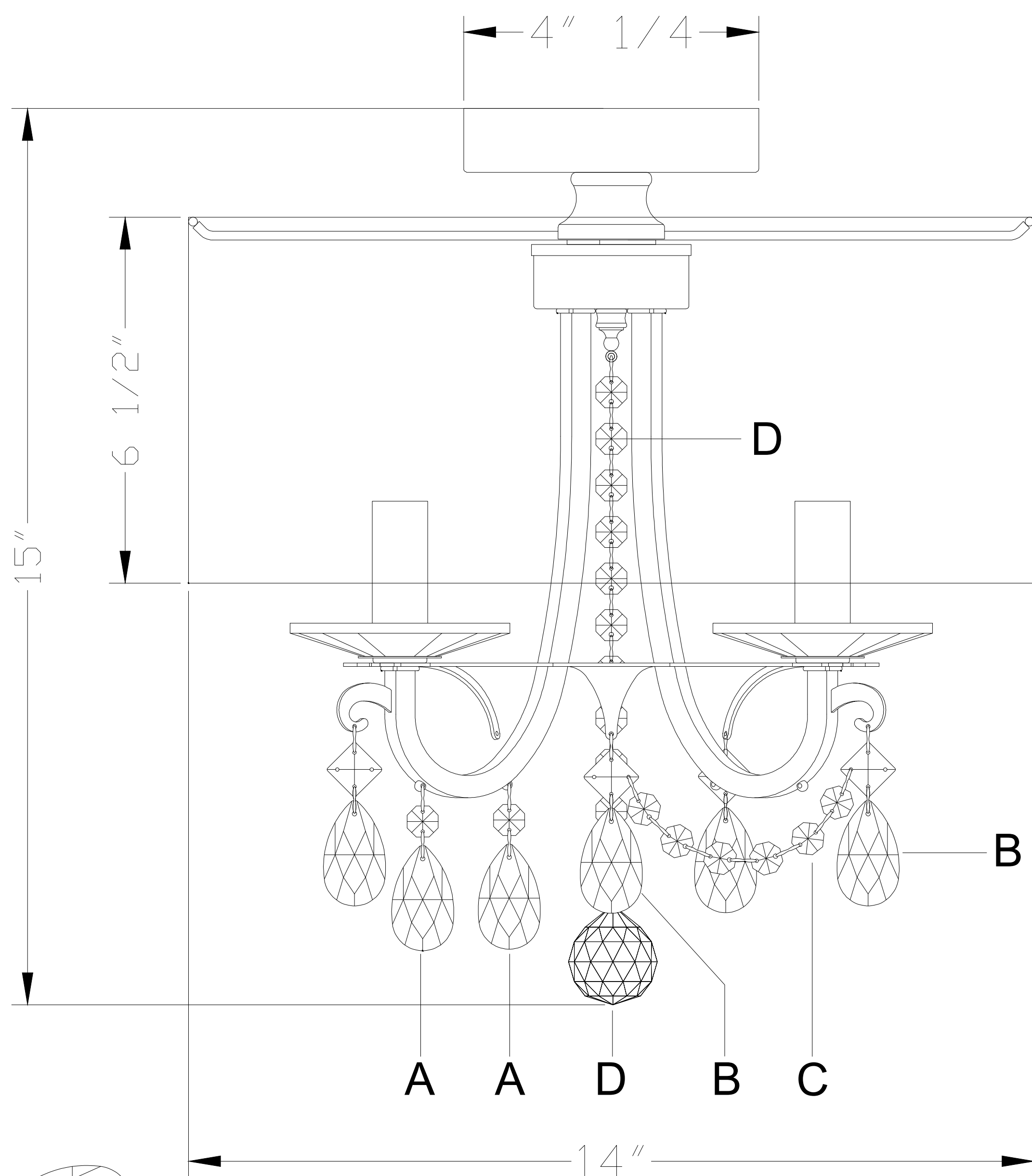
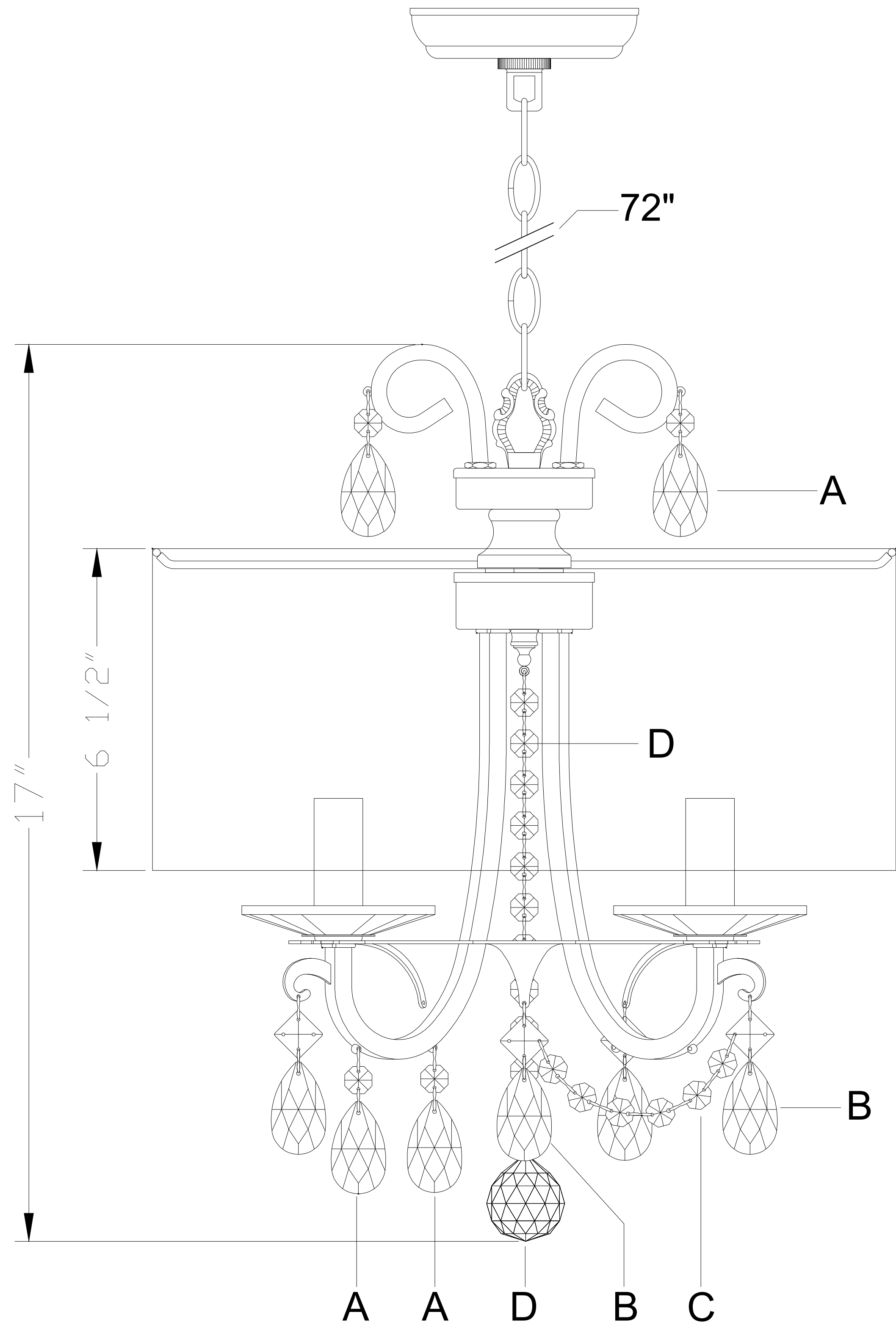

All electrical components must be installed by a licensed electrician in accordance with the National Electric Code and the appropriate local electrical codes.

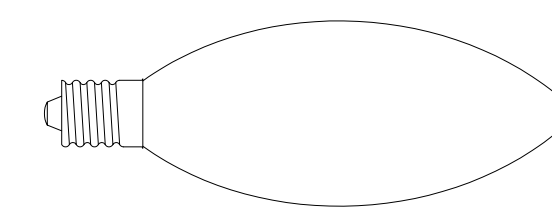
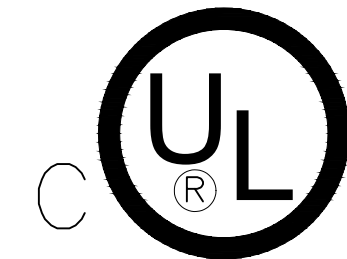

You will need 3-Candelabra Base Bulb
40Watts Recommended 60 Watts Max.

USE LED BULBS FOR EXTENDED USE

The fixture is damp rated

How to Install

For hanging:

1. Place the shade over the frame then place the top assembly over the shade. Make sure the slot in the top assembly is aligned with the shade spoke. Secure the shade with the loop.

For ceiling:

1. Place the shade over the frame then place the canopy 2 over the shade. Make sure the slot in canopy 2 is aligned with the shade spoke. Secure the shade with a hex nut.
2. After safely attaching the fixture into the outlet box, install bobeches, bulbs and proceed to connecting the power
3. When you begin to dress the fixture, start with packet labeled (A)
4. **IMPORTANT:** Apply crystal sets in alphabetical order

Crystal Sets

- A. (14mm+50mm)x9sets
- B. (Square+50mm)x6sets
- C. (14mmx6Pcs)x6sets
- D. (14mmx11Pcs+30mm Ball)x1set

WARNING: This product can expose you to lead which is known to the State of California to cause cancer and/or birth defects or reproductive harm For more information go to www.P65Warnings.ca.gov

CRYSTORAMA

LIGHTING THE WAY FOR SIXTY YEARS

ASSEMBLY INSTRUCTION MODEL #6623-MK-CL-MWP_CEILING

Part Number

Part Numbers

- A. (3)-Wire Connector
- B. (1)-Mounting Plate
- C. (1)-Ground Screw
- D. (1)-Nipple
- E. (2)-Outlet Box Screws
- F. (1)-Canopy 1 (W5.1"xH1") XEH6623MKCAN5IN
- G. (1)-Collar Loop
- H. (1)-Collar Ring
- I. (1)-Chain;72",4mm XEH6623MKCHA4MM
- J. (1)-Top Assembly
- K. (1)-Frame
- L. (1)-Fabric Shade (W14"xH6.5") XEH6623SHA14IN
- M. (3)-Bobecbe (D3.9" x Hole:1") XEH6623BOB4IN
- N. (3)-Metal Sleeve (H2.75")XEH6623MKMCDL2.75IN
- O. (3)-Plastic Sleeve (H2.75") XEH6623PCDL2.75IN
- P. (1)-Canopy 2(W4.25"xH1") XEH6623MKCAN4.25IN
- Q. (2)-Ball Nuts XEH6623MKBANUT
- R. (2)-Screws
- S. (3)-Wire Connector

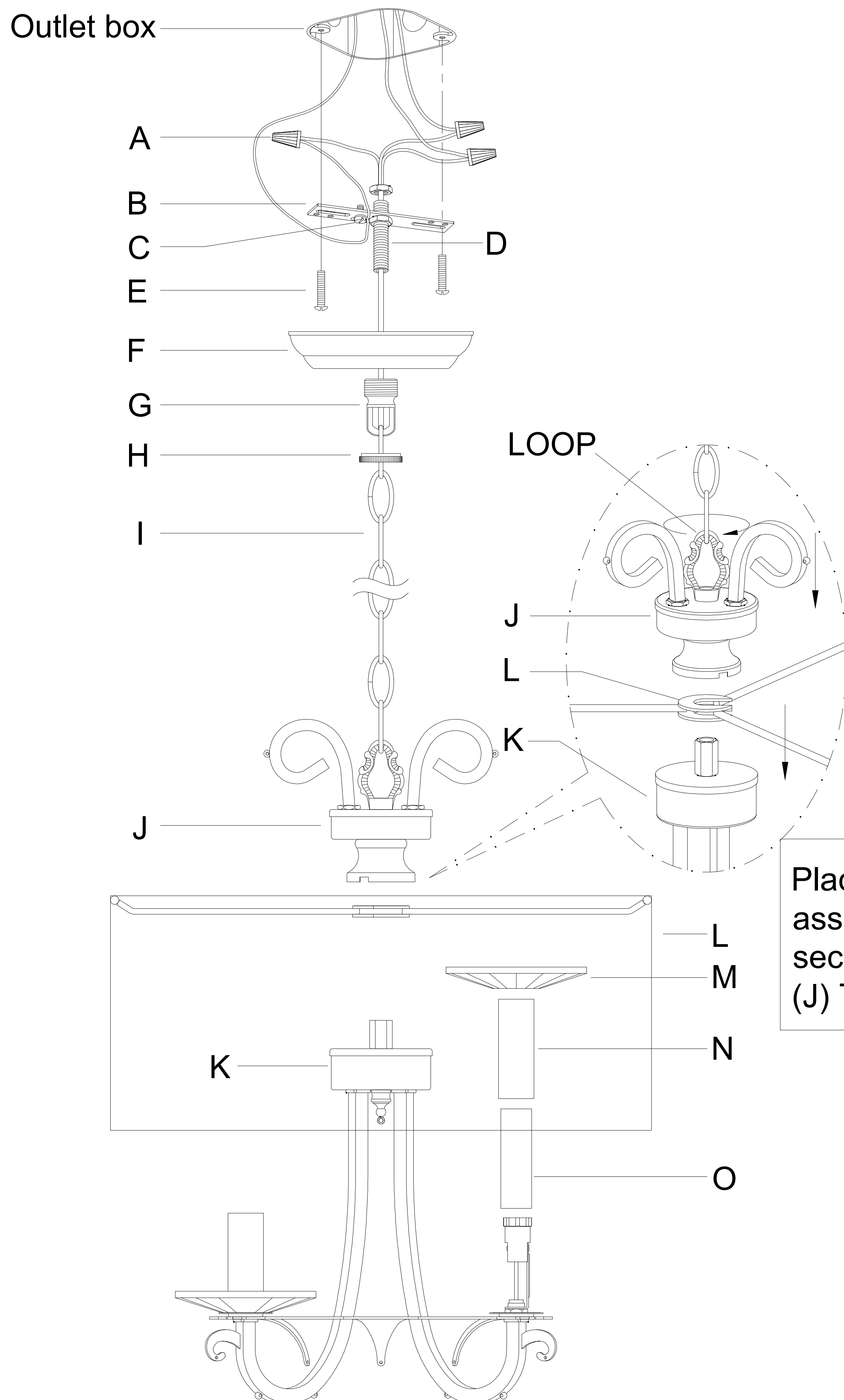

Place the (L) Fabric shade and (J) Top assembly on top of (K) Frame then secure by tightening the loop on the (J) Top Assembly.

For Ceiling

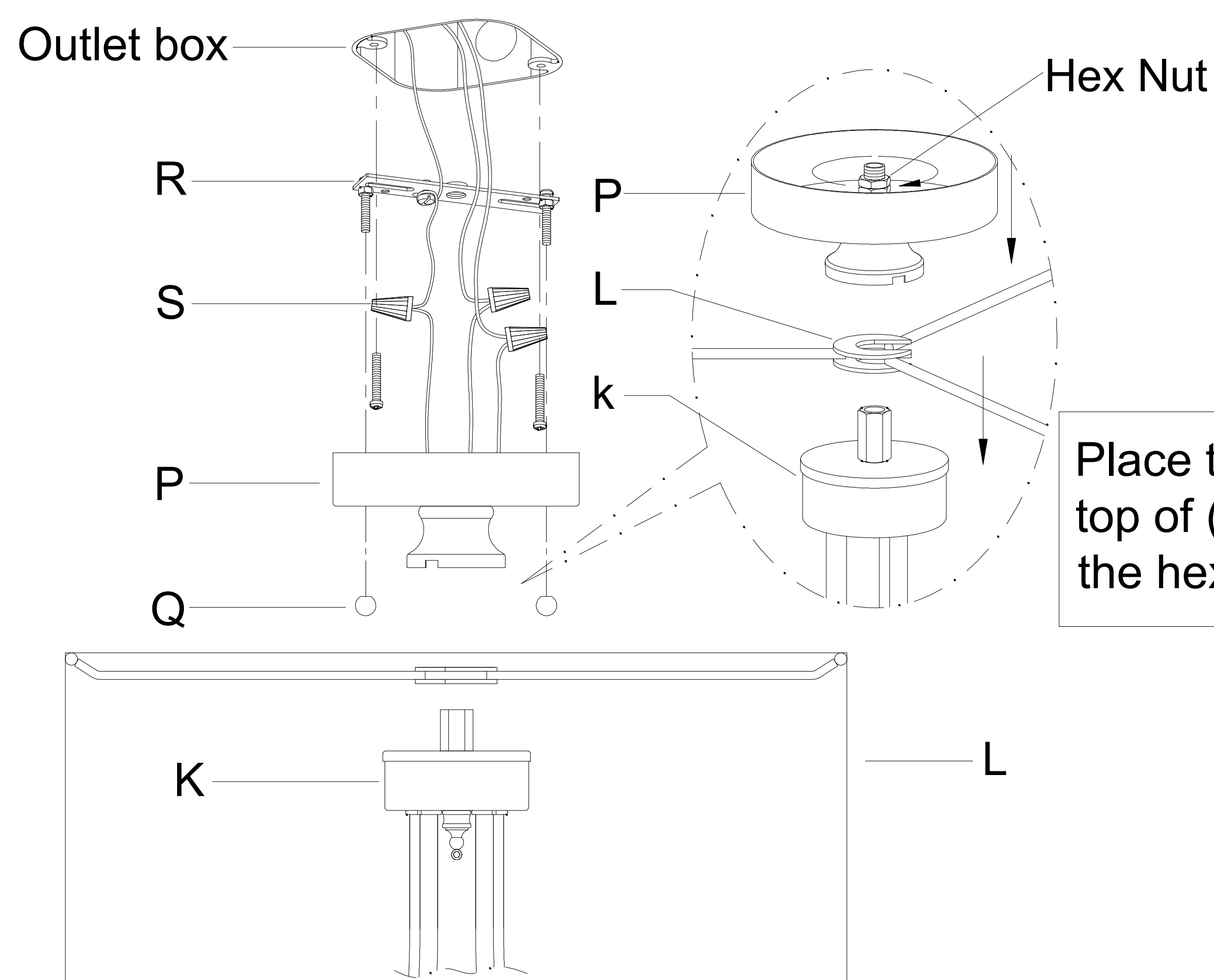

Place the (L) Fabric shade and (P) Canopy on top of (K) Frame then secure by tightening the hex nut on the (P) Canopy