

MS12250P

INSTALLATION GUIDE

lioni towel warmer,
plug-in

BRUSHED NICKEL(BN)



CHROME(CH)



BLACK(BK)

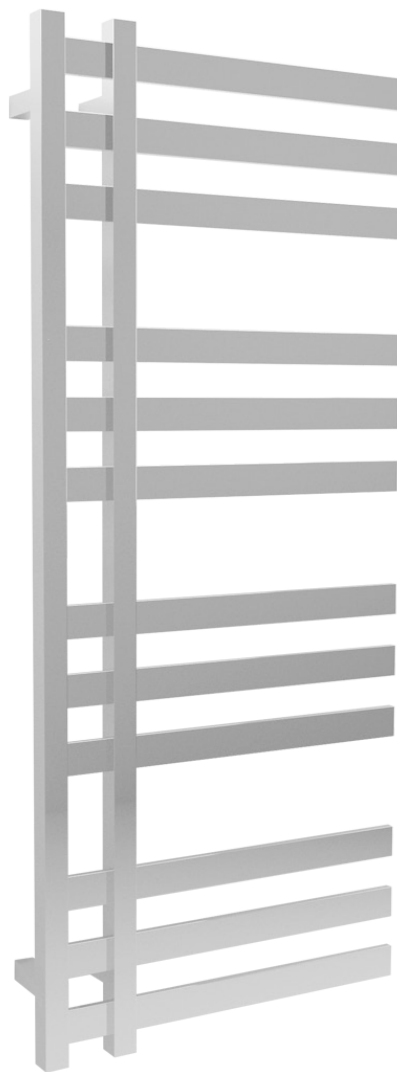

artos[®]

MS12250P

ioni towel warmer,
plug-in

OPERATING SPECIFICATIONS

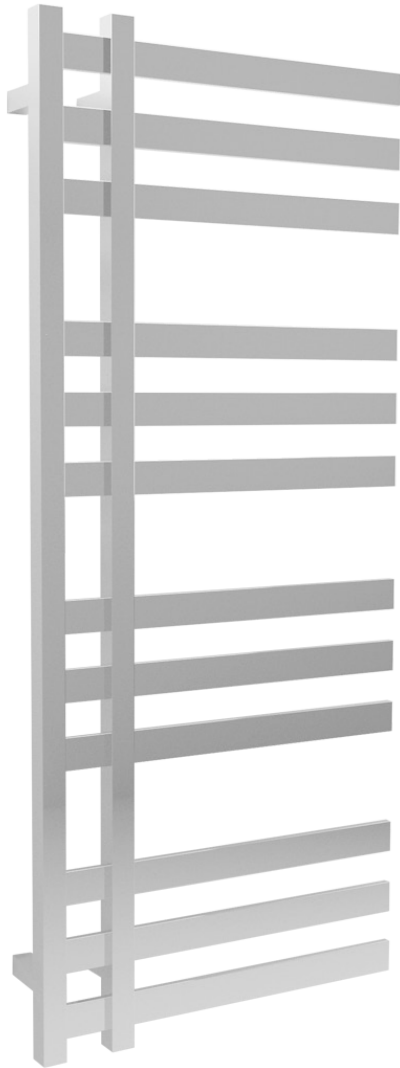

FEATURES

Towel warming, drying and auxiliary heating.

ELEMENT

300W, 110V

CODES

UL Approved

CSA-US Approved

REQUIREMENTS

The towel warmer must be installed so that the Element is at the bottom.

MS12250P

PRODUCT DIMENSIONS

ioni towel warmer,
plug-in

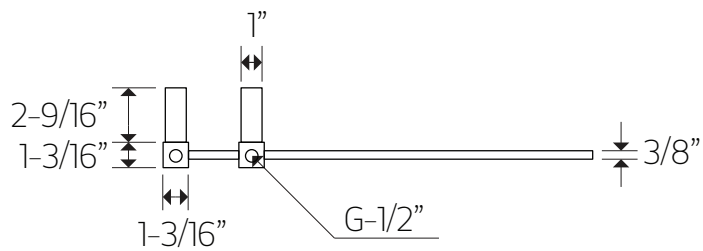
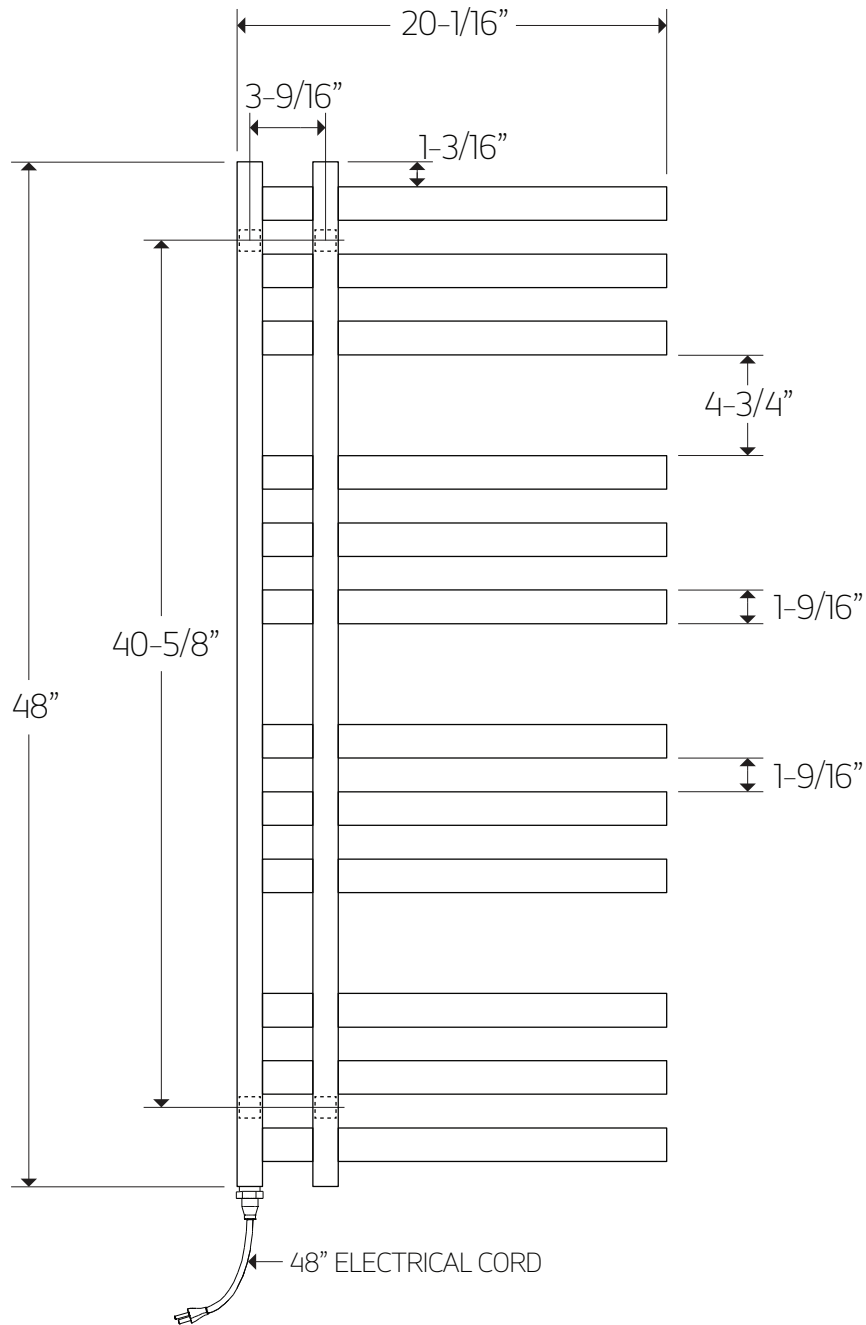

artos[®]

MS12250P

ioni towel warmer,
plug-in

STEP 1

WE RECOMMEND THAT AT LEAST
2 OF THE WALL BRACKETS ARE
SECURED INTO A STUD OR BACKER

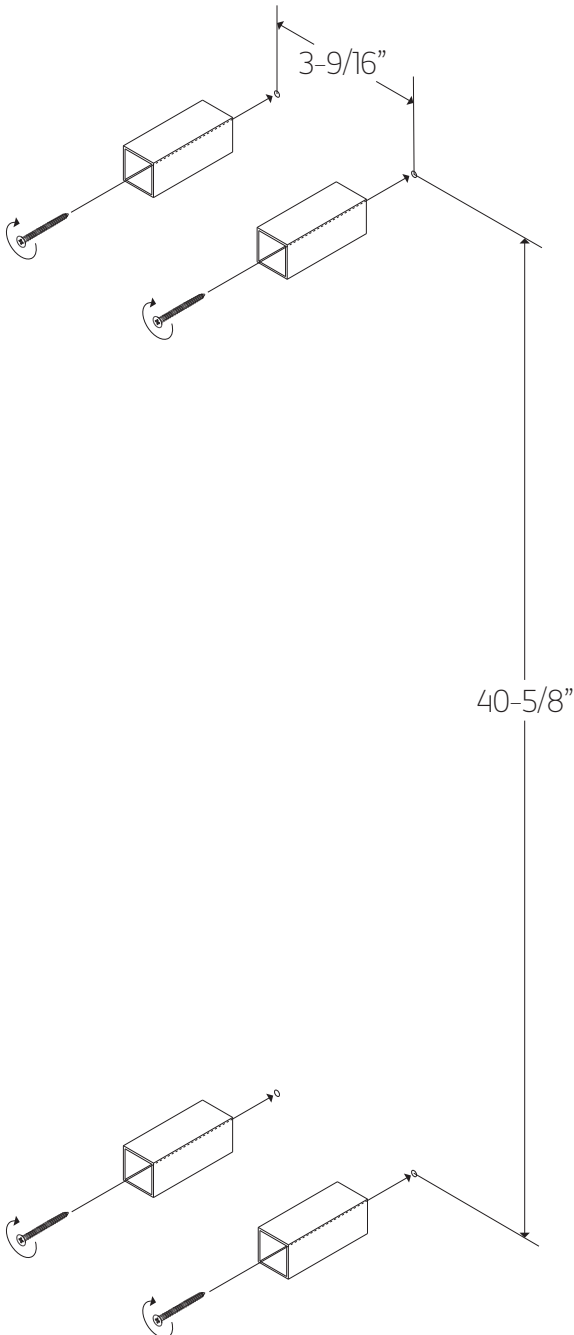

STEP 2

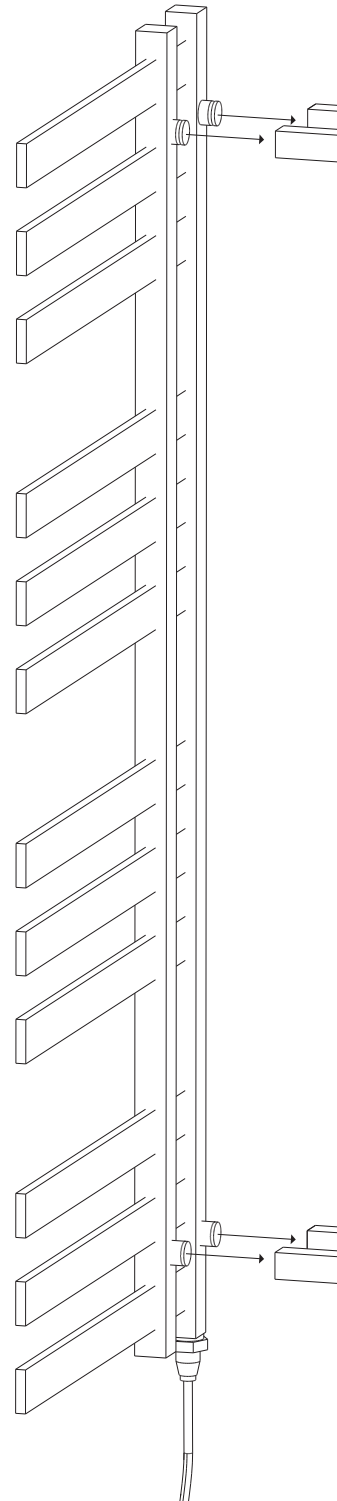

INSTALLATION STEPS

STEP 3 TIGHTEN 4 SET SCREWS,
1 PER BRACKET

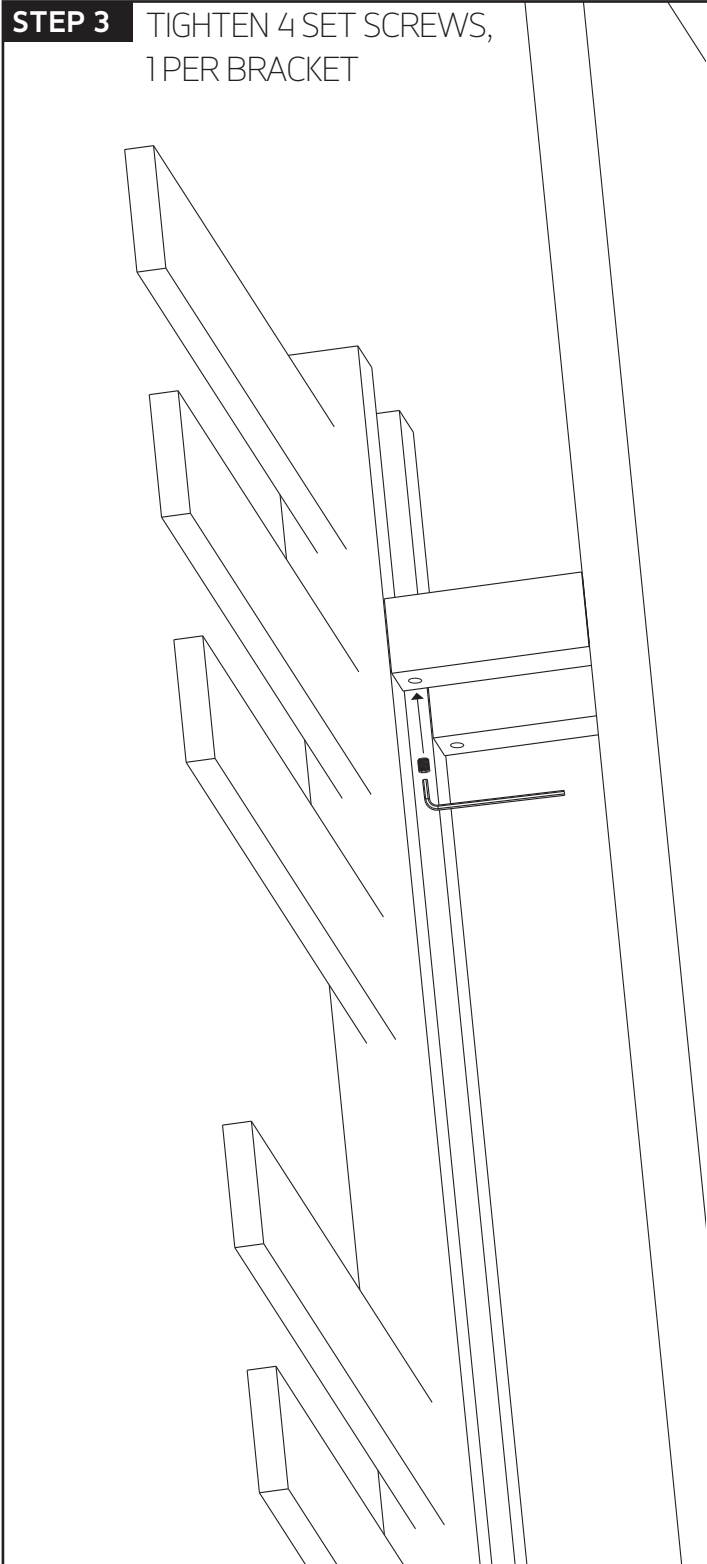

artos[®]

MS12250P

lioni towel warmer,
plug-in

PARTS BREAKDOWN

