

M06860P

INSTALLATION GUIDE

denby towel warmer,
plug-in

BRUSHED NICKEL(BN)



CHROME(CH)



POLISHED NICKEL(PN)



BLACK(BK)



artos[®]

M06860P

denby towel warmer,
plug-in

OPERATING SPECIFICATIONS



FEATURES

Towel warming, drying and auxiliary heating.

ELEMENT

300W, 110V

CODES

UL Approved

CSA-US Approved

REQUIREMENTS

The towel warmer must be installed so that the Element is at the bottom.

M06860P

PRODUCT DIMENSIONS

denby towel warmer,
plug-in

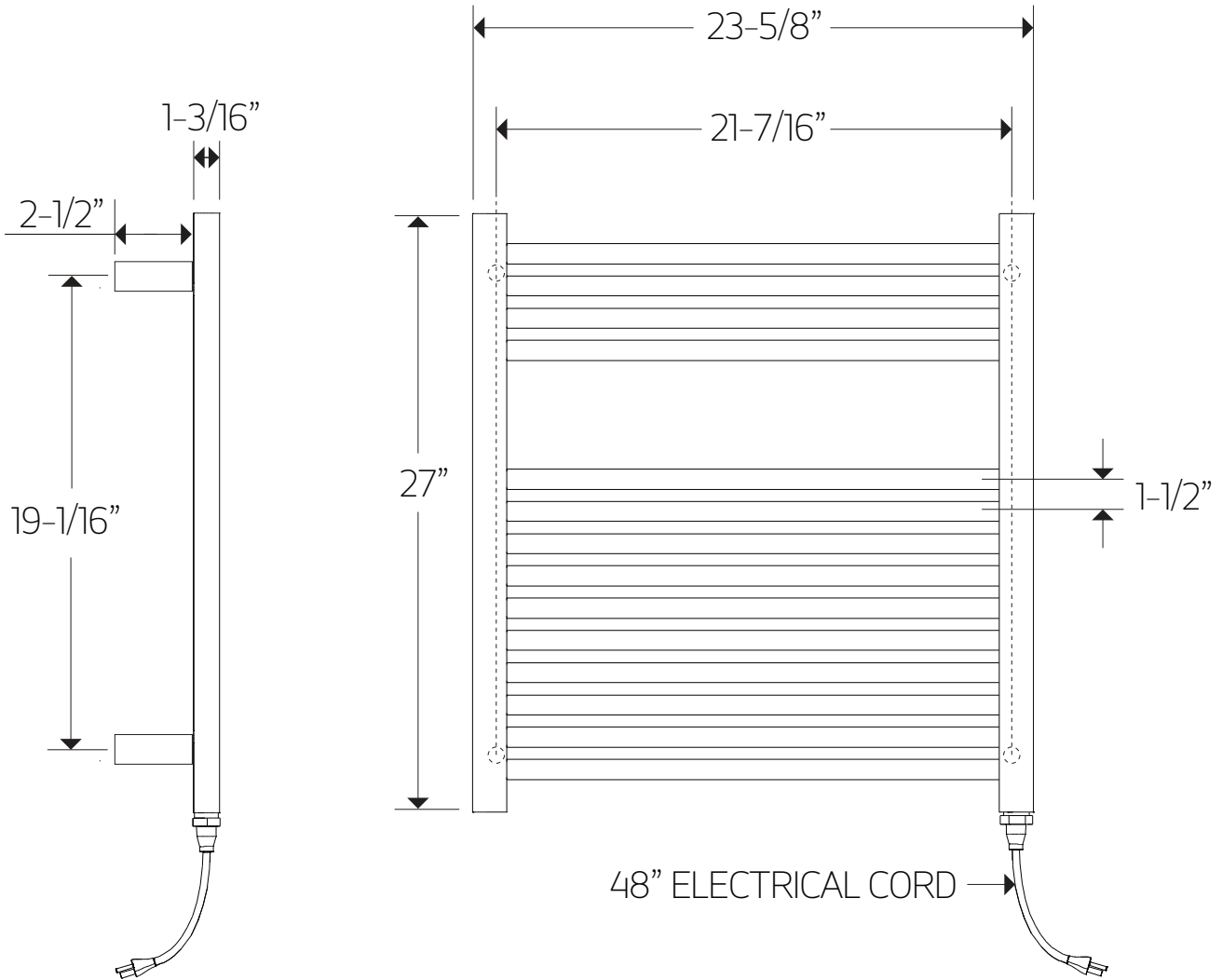

artos[®]

M06860P

denby towel warmer,
plug-in

STEP 1

*DIMENSIONS ARE APPROXIMATE FOR
BLOCKING PURPOSES, PLEASE MEASURE UNIT

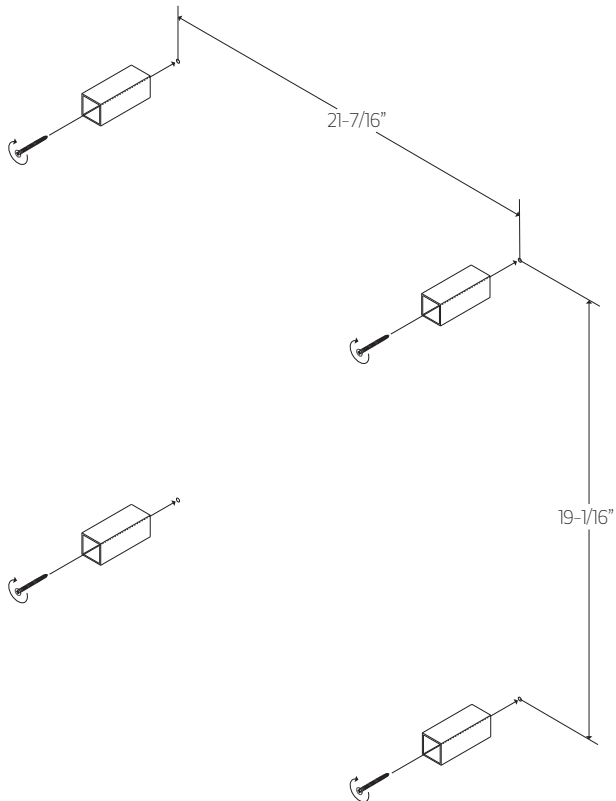

STEP 2

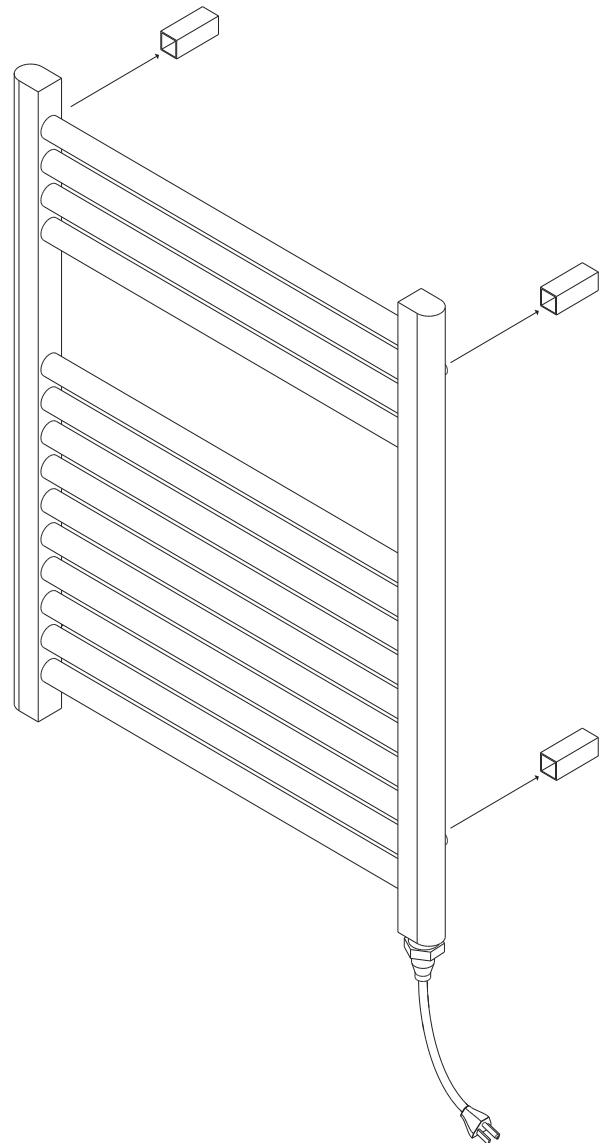

WE RECOMMEND THAT AT LEAST
2 OF THE WALL BRACKETS ARE
SECURED INTO A STUD OR BACKER

INSTALLATION STEPS

STEP 3

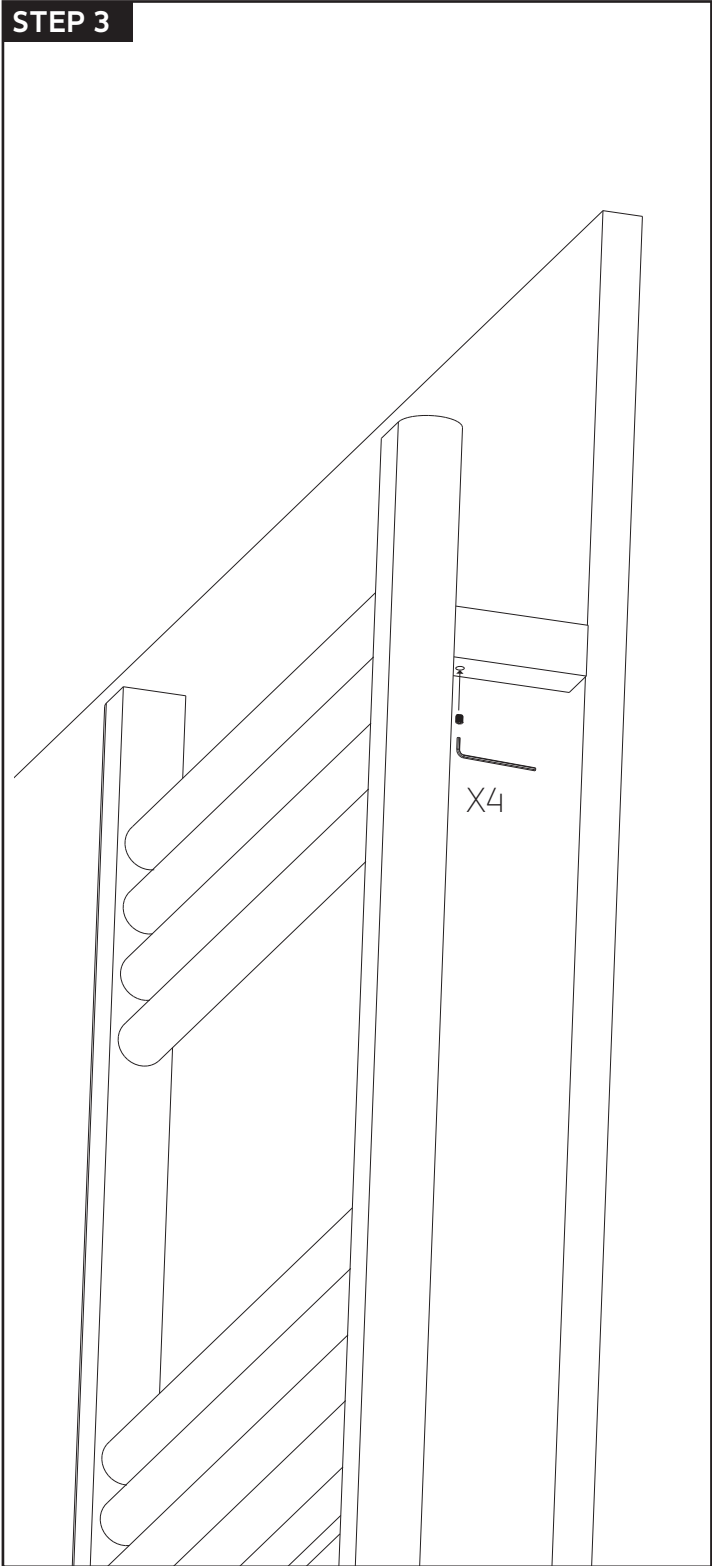

artos[®]

M06860P

denby towel warmer,
plug-in

PARTS BREAKDOWN

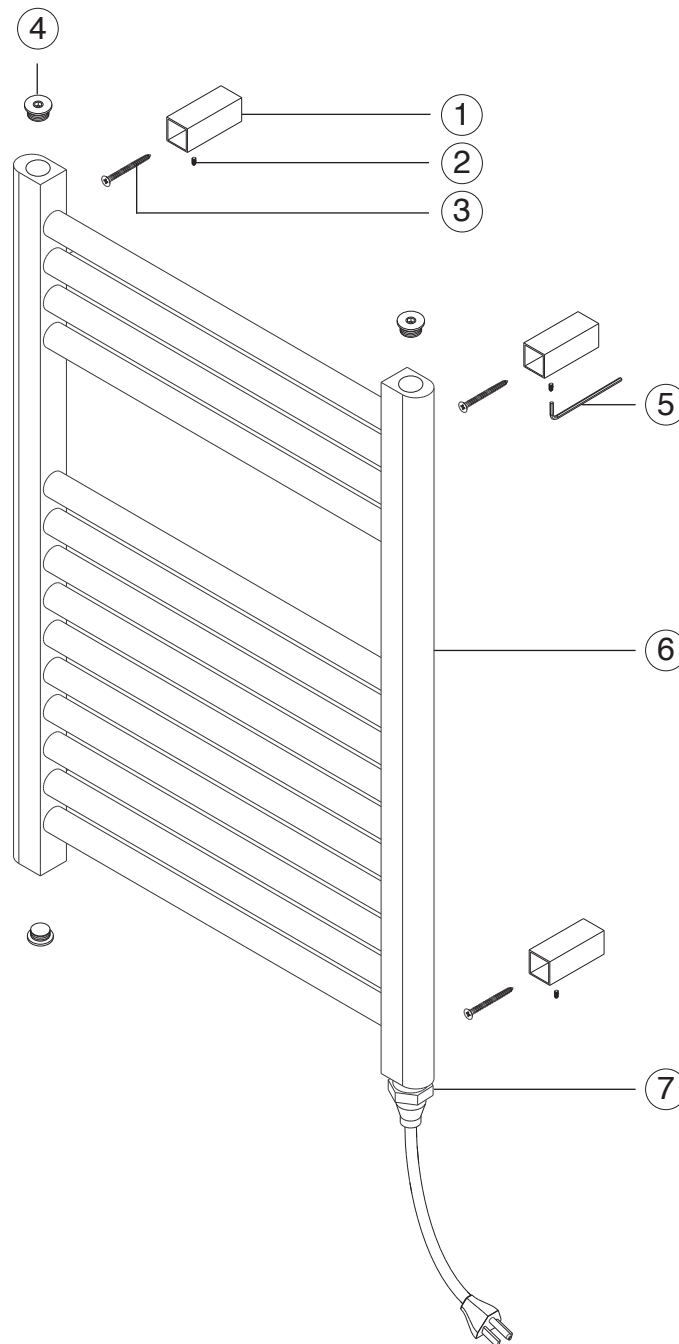

- ① WALL BRACKET(4)
- ② BRACKET SET SCREW(4)
- ③ BRACKET SCREW(4)
- ④ BLANKING CAP(3)
- ⑤ ALLEN WRENCH
- ⑥ TOWEL WARMER
- ⑦ ELEMENT