

# F907-90

Round Slide Bar

artos®

INSTALLATION GUIDE



# F907-90

Round Slide Bar

artos®

## OPERATING SPECIFICATIONS



### OPERATING PRESSURE

Minimum: 20psi

Maximum: 125psi

Recommended: 30psi-95psi

Operating pressures (on hot and cold lines) should be kept as balanced as possible, in order to assure the maximum efficiency.

### STANDARDS



All technical specifications, product details, and pricing are subject to change without prior notice. Artos makes every effort to ensure accuracy; however, errors or omissions may occur. It is the responsibility of the installer, designer, or purchaser to verify all critical dimensions, installation requirements, and compliance with applicable codes prior to use.

Artos assumes no liability for damages, losses, or injuries resulting from the use of this documentation or from product installation, operation, or maintenance performed outside of Artos instructions and applicable codes. Product warranties are limited to those expressly stated by Artos. Please refer to official warranty documentation for complete terms and conditions.

All drawings, manuals, and specifications are the property of Artos and may not be reproduced, distributed, or altered without prior written permission.

# F907-90

Round Slide Bar

artos®

**INDEX**

## INDEX

Product Dimensions.....pg:4

Round Slide Bar Installation F907-90.....pg:5-9

Parts Breakdown F907-90.....pg:10

# F907-90

Round Slide Bar

artos®

## PRODUCT DIMENSIONS

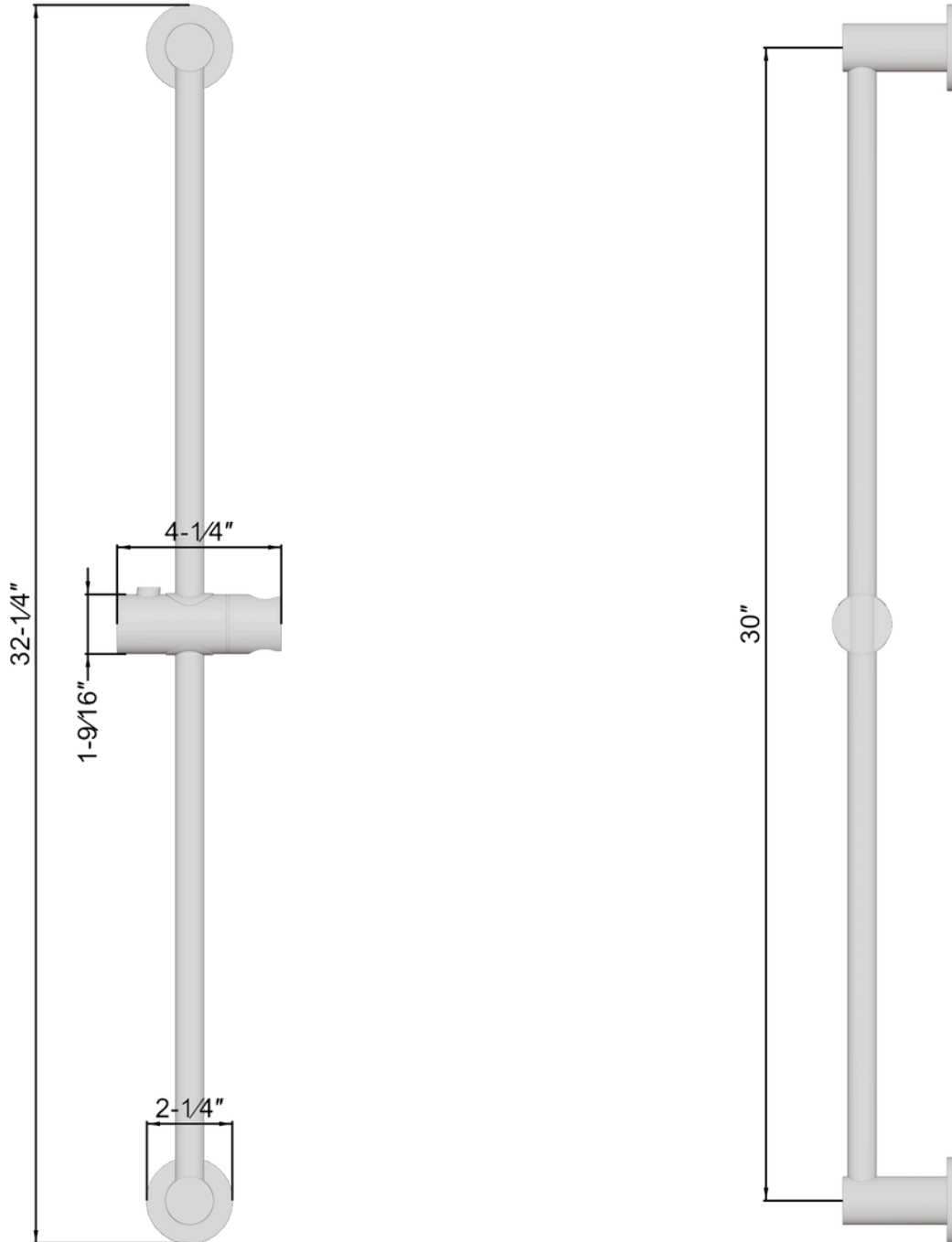

## STEP 1

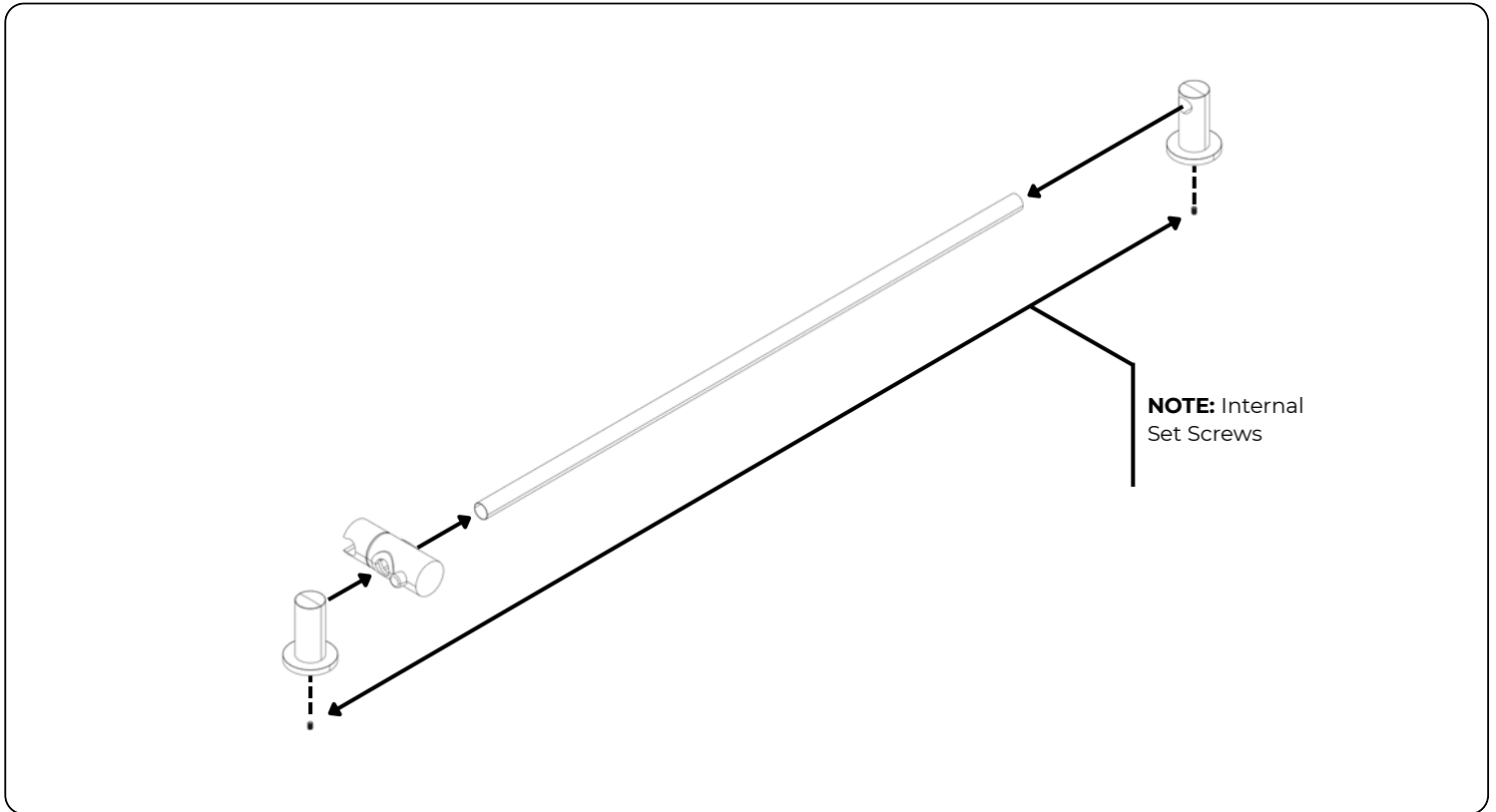

Assemble the slide bar by positioning the adjustable shower wand holder at the midpoint of the bar. Attach a slide bar arm to each end and tighten the set screw inside each slide bar end to secure it to the bar. Slide the escutcheon over the bottom of each slide bar end.

**Note:** If slide bar spins in final step tighten internal set screws

## STEP 2

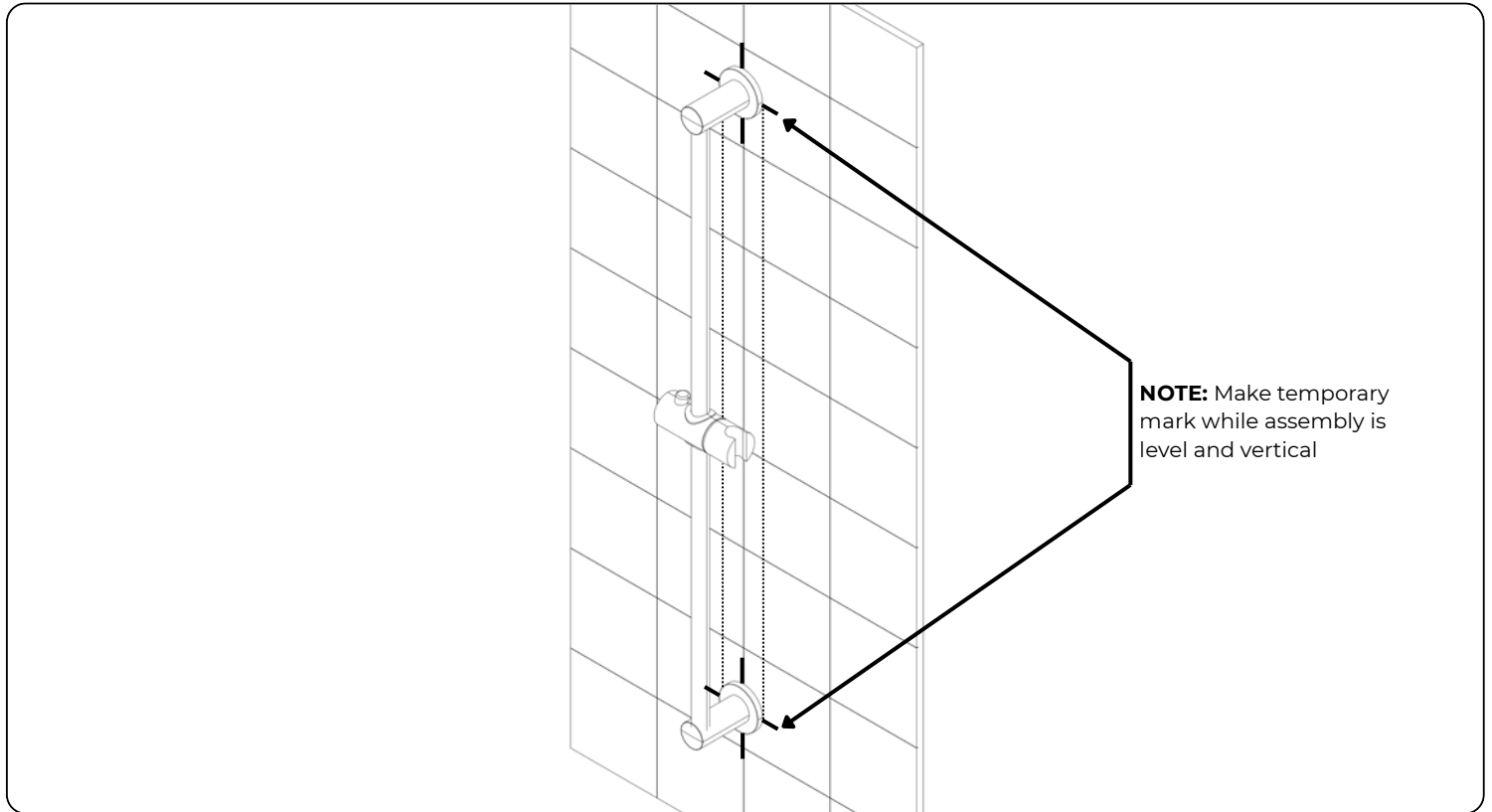

Hold the assembled slide bar vertically against the wall to verify proper alignment. Mark the wall at the positions where the upper and lower slide bar arms will be mounted. Once marked, remove the assembly and set it aside.

## STEP 3

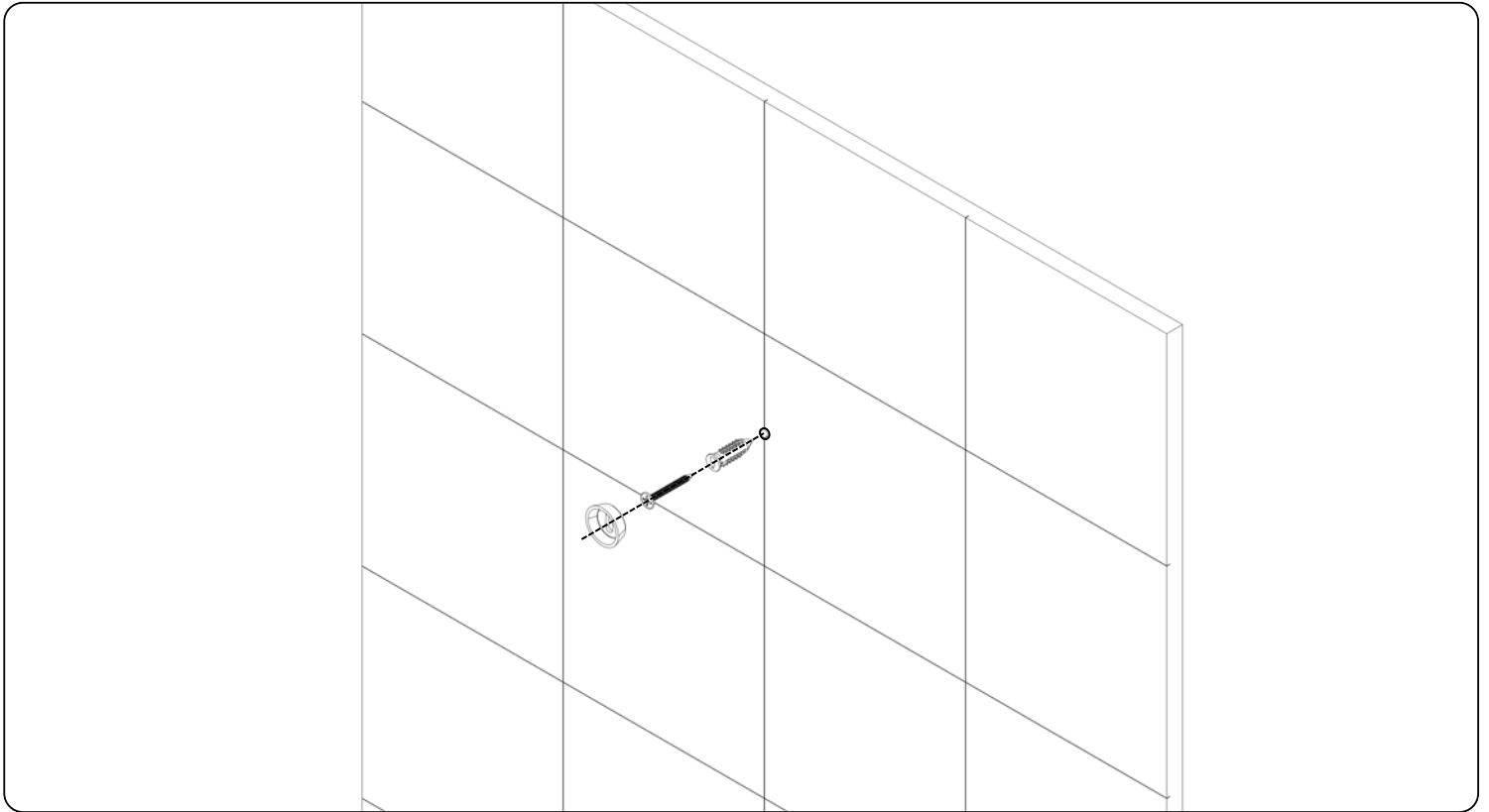

Using a tile-safe drill bit, drill a **3/16**-inch pilot hole at each marked location, penetrating both the tile and backer board. Insert the provided wall anchor until it is flush with the wall surface. Place the brass washer cap over the drywall screw with the flat side facing the wall, then drive the screw into the anchor until snug.

**Note:** Do not oversize the pilot hole, as this may compromise the grip of the wall anchor and result in loosening over time.

# F907-90

Round Slide Bar

artos®

## INSTALLATION GUIDE

### STEP 4

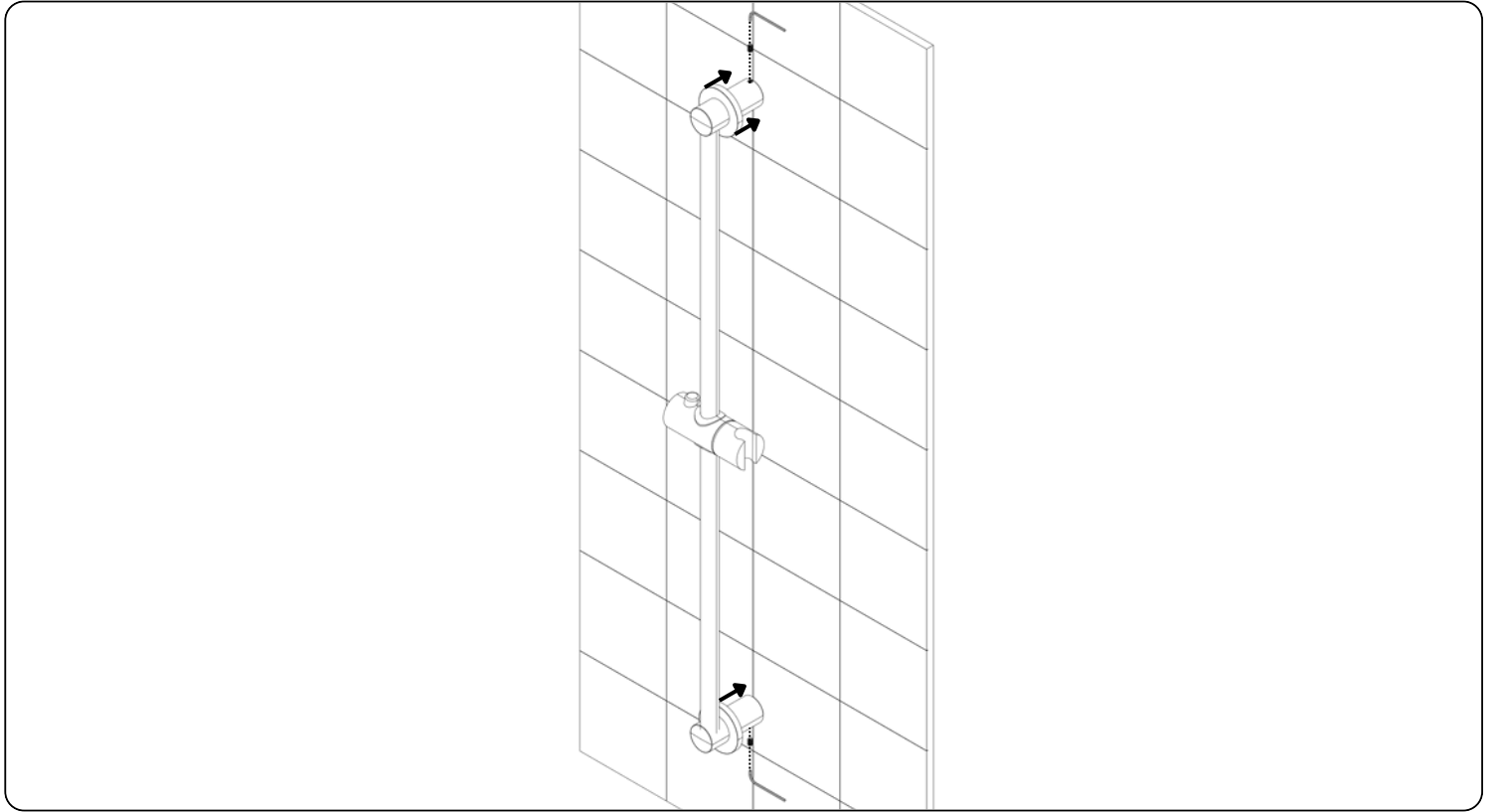

Reposition the slide bar assembly and tighten the set screw located behind the escutcheon onto the brass cap to secure the assembly in place. Slide the escutcheon plate over the arm until it sits flush against the wall.

## STEP 5

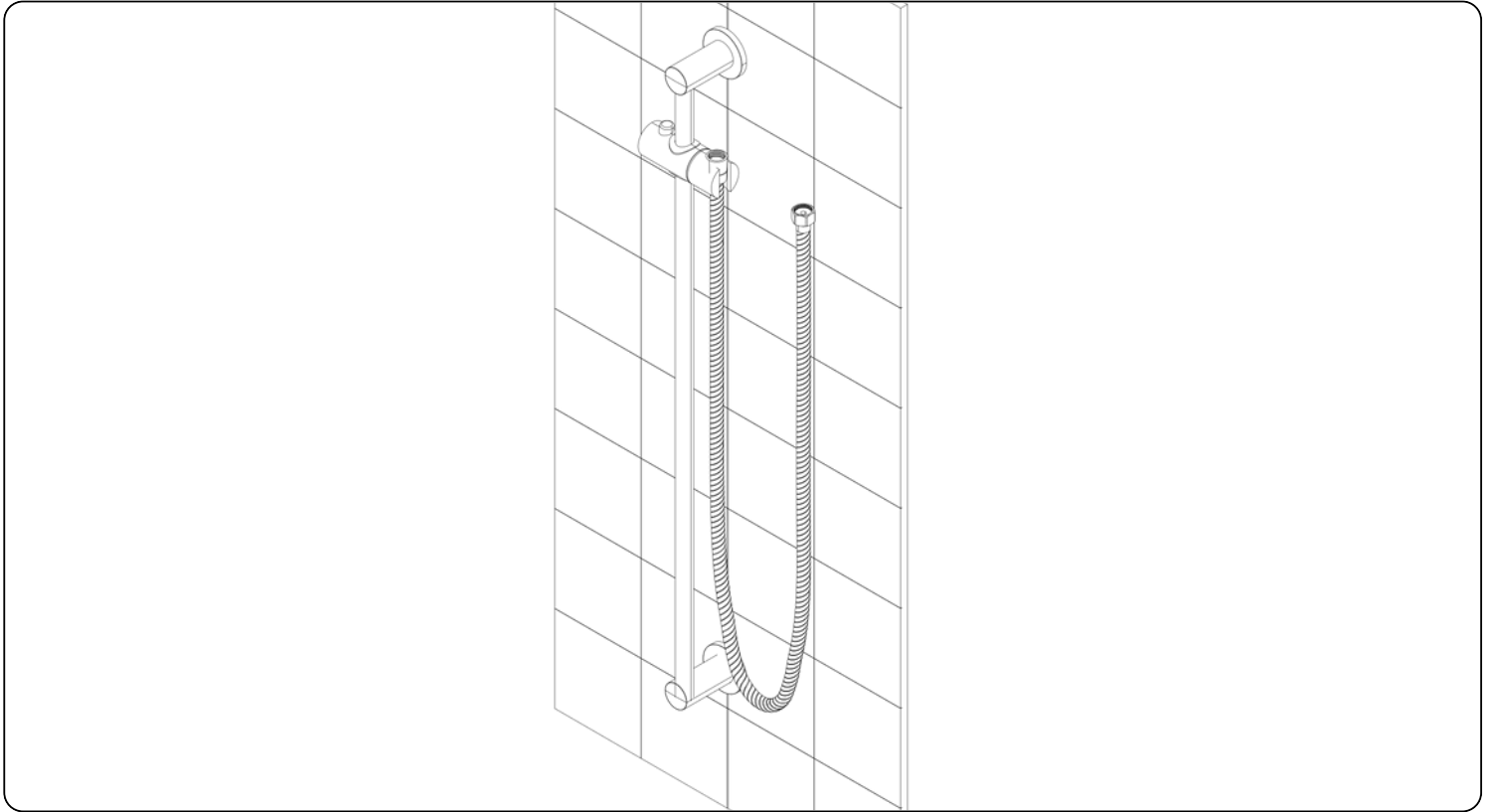

Place the tapered end of the shower wand hose into the adjustable shower wand holder, ensuring the shower wand is properly seated within the holder channel. Install the water outlet and escutcheon in accordance with their respective installation instructions. Once completed, securely tighten the hose nut onto the outlet.

Conduct a final inspection to verify that the slide bar assembly is vertically aligned and that all components are securely fastened. Restore the water supply and test the system for leaks at all connection points. Make any necessary adjustments to ensure proper operation before finalizing the installation.

# F907-90

Round Slide Bar

artos®

## PARTS BREAKDOWN

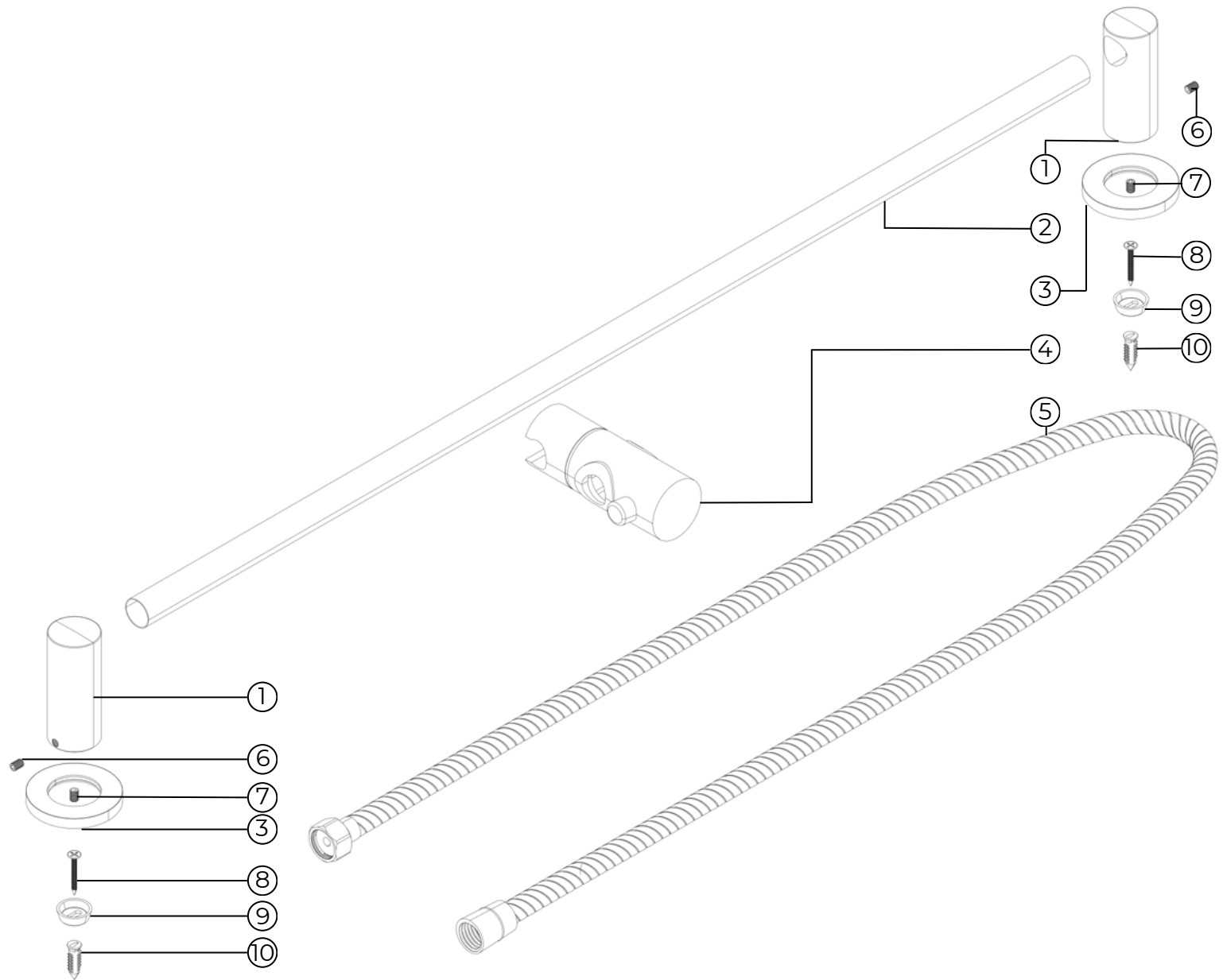

- ① SLIDE BAR ARM
- ② SLIDE BAR
- ③ ROUND SLIDE BAR ARM ESCUTCHEON
- ④ AJUSTABLE SHOWER WAND HOLDER
- ⑤ SHOWER WAND HOSE
- ⑥ SLIDE BAR SET SCREW

- ⑦ WALL CAP SET SCREW
- ⑧ DRYWALL SCREW
- ⑨ BRASS WALL CAP
- ⑩ WALL ANCHOR