

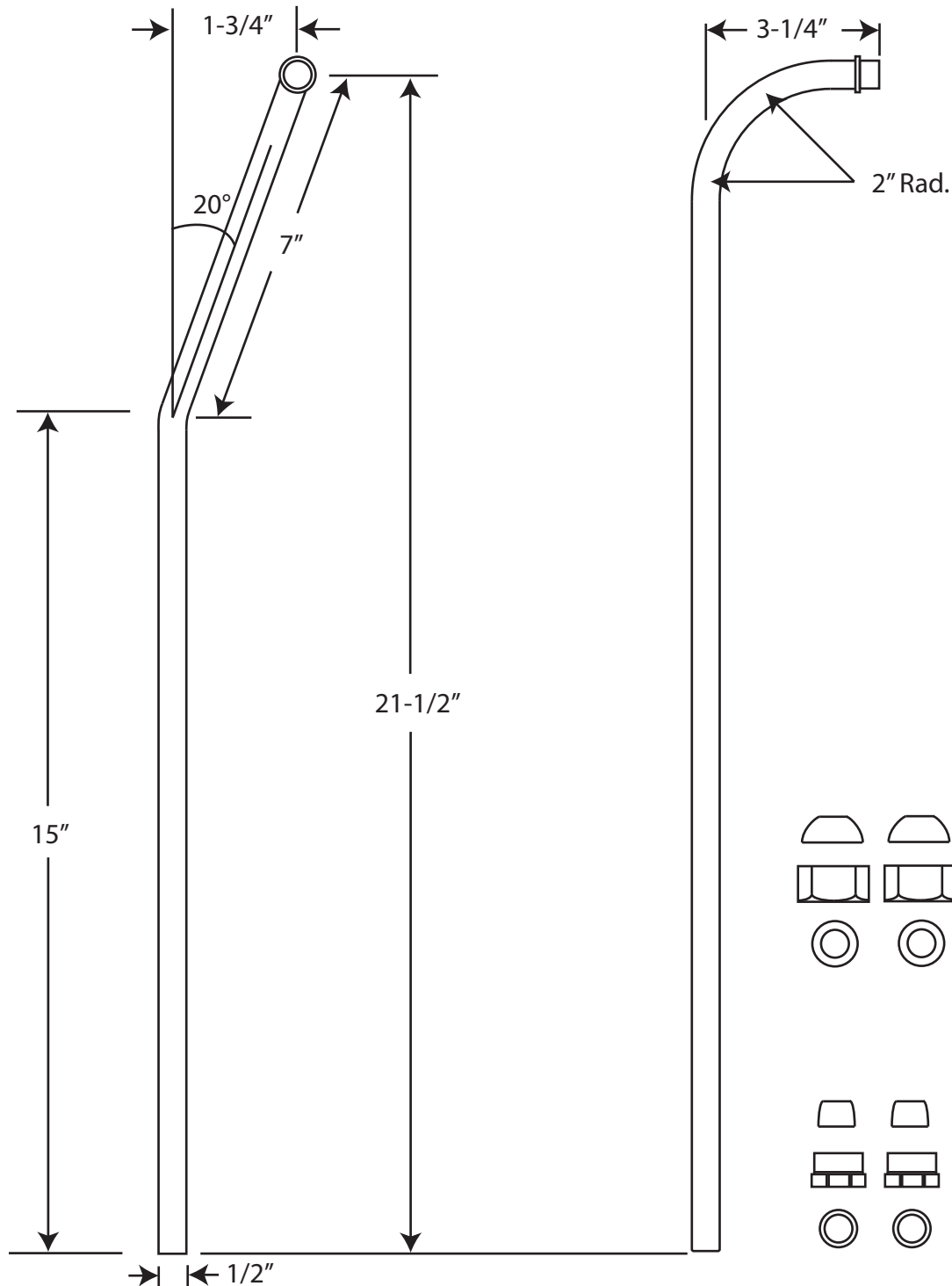











# D136 Double Offset Supply Tubes

Two Tubes, 4 Nuts and Washers



-   3/4" Cone Washer
-   3/4" MIP x 1/2" Nuts
-   Brass Washer
-   1/2" Cone Washer
-   1/2" Slip Joint Nuts
-   Brass Washer