

Features

Solid brass construction
Euro-motion ceramic disc 35 mm valve cartridge
Cartridge stem adapter ensures secure handle-to-stem interface
Two-function, push-button control spray engine with solid brass housing
Magnetic docking system secures spray engine to spout
Pivoting-ball spray engine inlet fitting for enhanced directional control
8.57" (21.8 cm) spout height at outlet
7.42" (18.8 cm) spout reach (c-c)
ADA Compliant (Handles Only)
1.8 GPM (6.8 LPM) Max

PULL-DOWN PREP SINK / BAR FAUCET

3190-5223



Codes / Standards Compliance

Meets or exceeds the following at date of manufacture:

ASME A112.18.1/CSA B125.1
IAPMO/cUPC
NSF/ANSI/CAN 61, SECTION 9
NSF/ANSI 372
IPC
ADA & ICC/ANSI A117.1 (Handle Only)
Energy Policy Act of 1992
California Energy Commission
ASME A112.18.3 (Back Flow)
All applicable US Federal and State material regulations

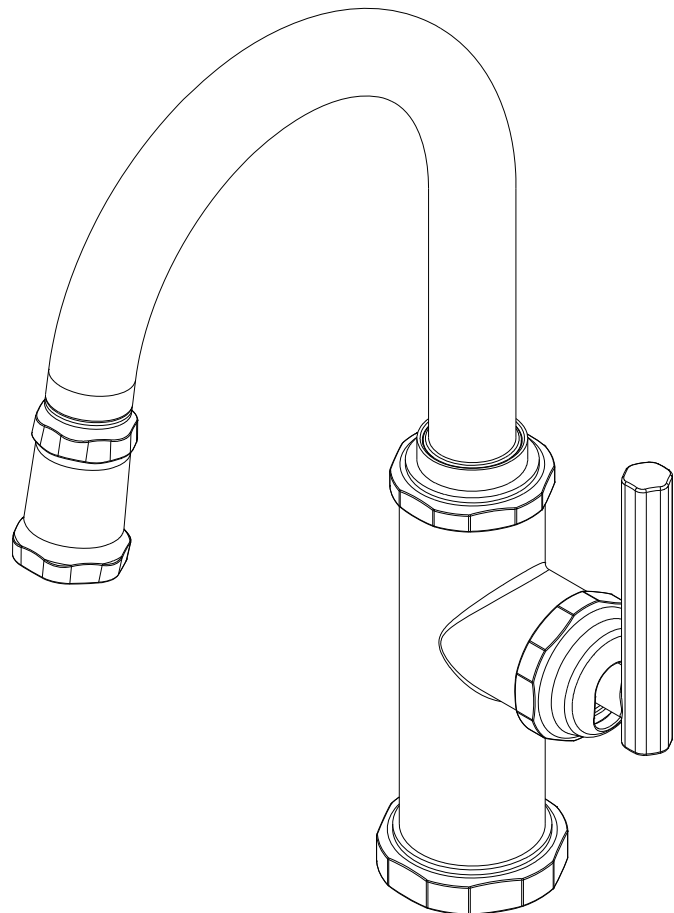

3190-5223

PRODUCT DIMENSIONS *(Units are in inches)*

Product Dimensions are provided for reference only. For specific product installation guidelines, please reference the Installation Instructions of the product being installed.

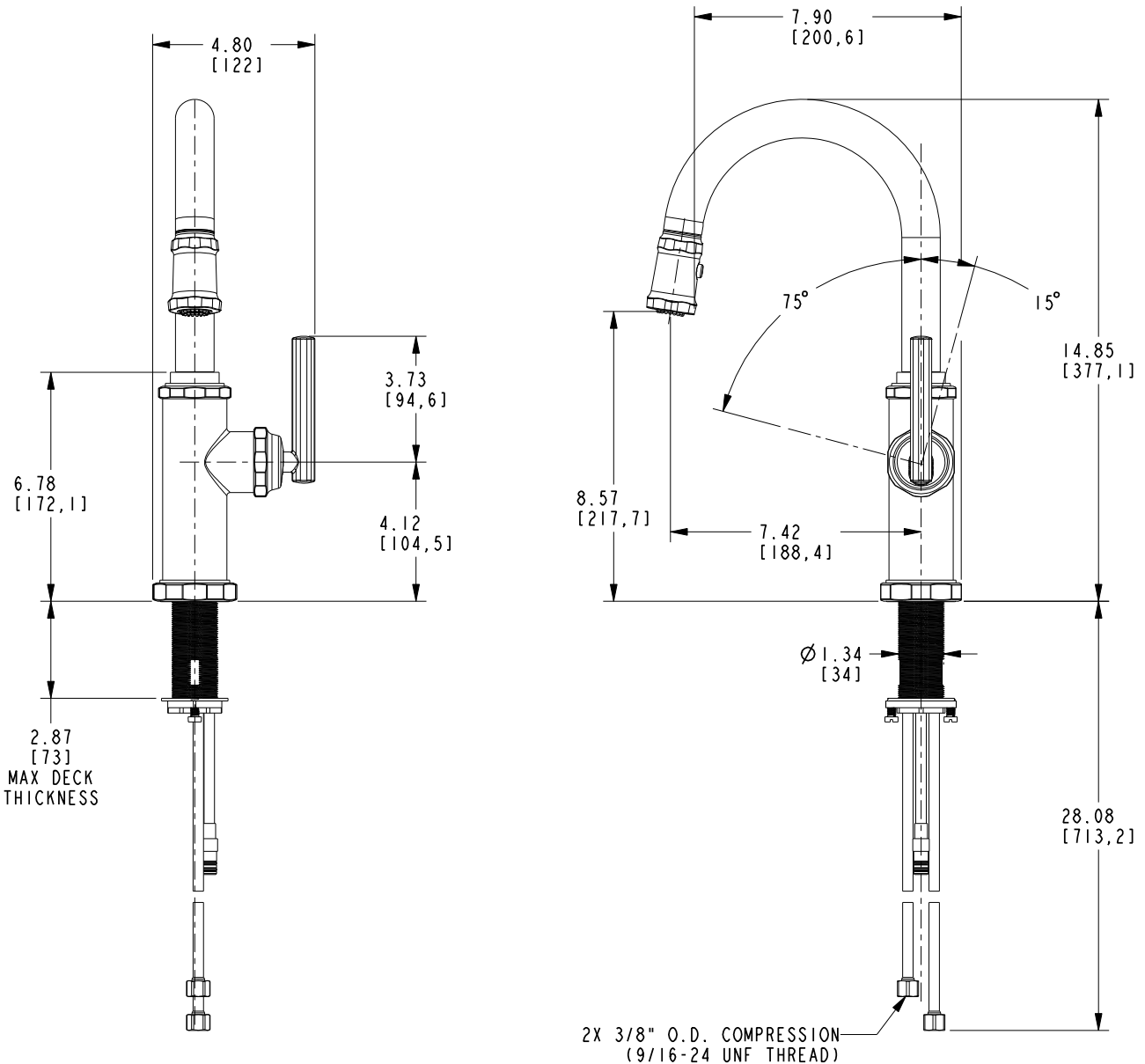

PULL-DOWN PREP SINK / BAR FAUCET

3190-5223

Page 2 of 2
EN- 5002
REV H

NEWPORT BRASS
Flawless Beauty. From Faucet to Finish.

t: 949.417.5207 | www.newportbrass.com
©2025 NewportBrass