

Features

- Solid brass construction
- Temperature-adjust handle for thermostatic valve
- Handle assembly for control valve
- Intended for use with Newport Brass rough valve(s) as specified (Required Accessory)

Thermostatic Shower System Trim
3-3324TR



Codes / Standards Compliance

Meets or exceeds the following at date of manufacture:

- ASME A112.18.1/CSA B125.1
- IAPMO/cUPC
- IPC
- All applicable US Federal and State material regulations

Colors / Finishes

- 10B: Oil Rubbed Bronze
- 15: Polished Nickel
- 15S: Satin Nickel - PVD
- 26: Polished Chrome
- Other: Refer to the Newport Brass catalog for additional color/finish options.

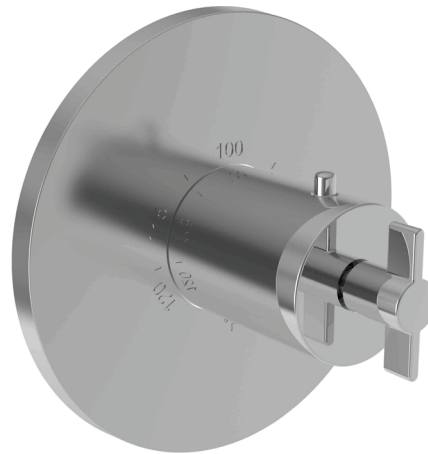

3-3324TR



3-721

Specified Model

Model	Description	Colors Finishes				
3-3324TR	Thermostatic Shower System Trim	<input type="checkbox"/> 10B	<input type="checkbox"/> 15	<input type="checkbox"/> 15S	<input type="checkbox"/> 26	<input type="checkbox"/> Other
3-721	Shower System Control Valve Trim (Escutcheon/Handle)	<input type="checkbox"/> 10B	<input type="checkbox"/> 15	<input type="checkbox"/> 15S	<input type="checkbox"/> 26	<input type="checkbox"/> Other

Required Accessory

System Element	Shower Temp. Control	Flow Control Valve Option A		Flow Control Valve Option B***	
Description	Thermostatic	3-Outlet Diverter w/OFF		Single Outlet ON/OFF	
Inlet/Outlet Size	3/4"	1/2" (no share function)	1/2" (w/share function)	1/2"	3/4"
Part Number	1-540	1-701*	1-702**	1-606U	1-607U
Image					

Product Specification

The Thermostatic Shower System Trim shall be made of solid brass construction. Thermostatic Shower System Trim shall include a faceplate and temperature-adjust handle. Shower System Control Valve Trim(s) (Escutcheon/Handle) shall be ADA compliant when used with specified Shower System Control Valve(s). Thermostatic Shower System Trim shall be Newport Brass Model 3-3324TR/_____ and Thermostatic Shower System Valve shall be Newport Brass Model 1-540. Shower System Control Valve Trim (Handle/Escutcheon) shall be 3-721/_____ and Shower System Control Valve(s) shall be 1-70 _____ (1 required) or 1-60 _____ (one required per outlet fixture).

3-3324TR

Product Dimensions are provided for reference only. For specific product installation guidelines, please reference the Installation Instructions of the product being installed.

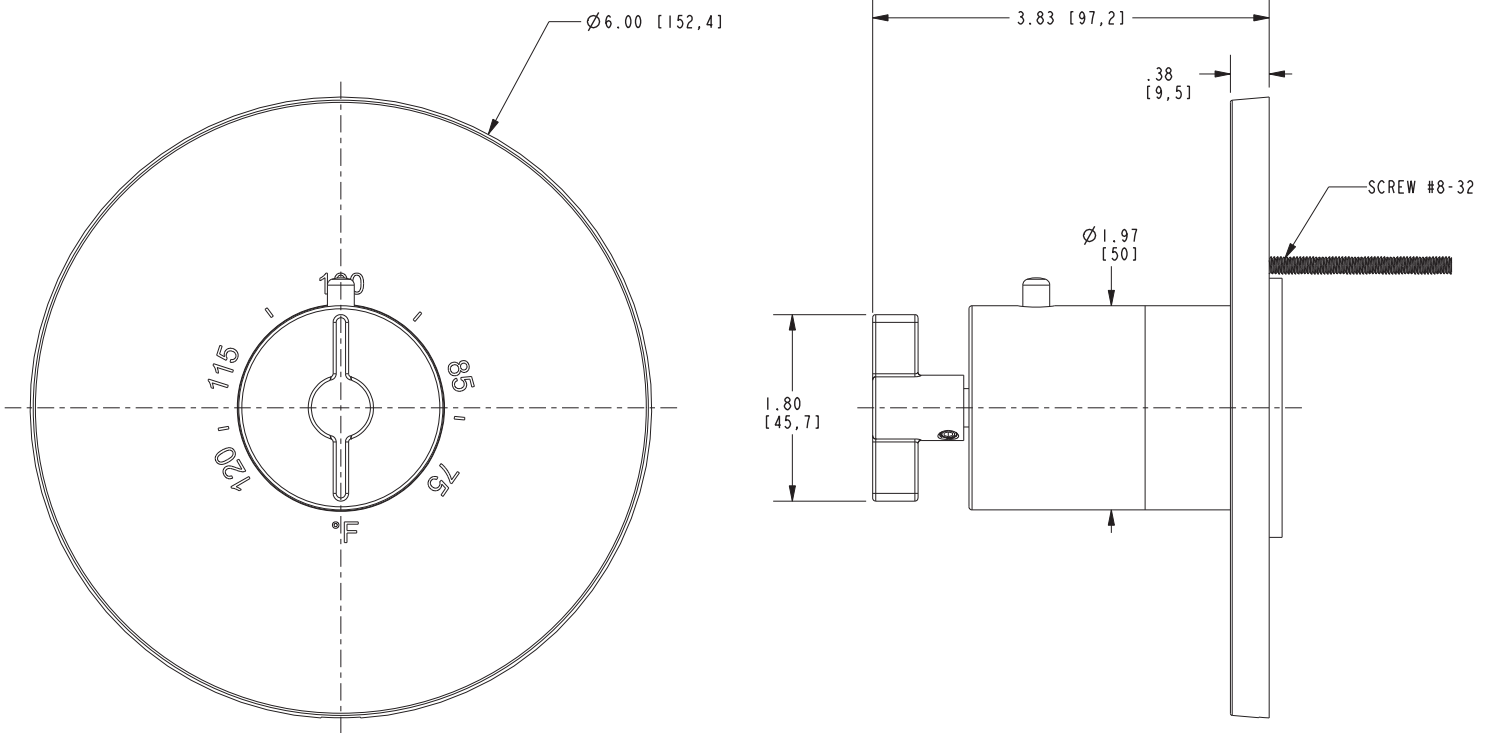

Tolmin Thermostatic Shower System Trim 3-3324TR