

Features

ROMAN TUB WITH HANDSHOWER DECK TRIM

3-3277



- Solid brass construction
- 6.50" (16.5 cm) spout height at outlet
- 8.25" (21.0 cm) spout reach (c-c)
- Diverter valve and hoses as needed for handshower
- ADA Compliant (Handles Only)
- 1.8 GPM (6.8 LPM) Max, Handshower Only
- Intended for use with Newport Brass rough valve kit (Accessory Required) which incorporates the following:
 - Brass valve bodies and quick-connect spout fitting
 - Quarter-turn washerless ceramic disc 3/4" valve cartridges

Codes / Standards Compliance

Meets or exceeds the following at date of manufacture:

- ASME A112.18.2/CAS B125.1-18
- IAPMO/cUPC
- IPC
- ADA & ICC/ANSI A117.1 (Handle Only)
- Energy Policy Act of 1992
- EPA WaterSense
- California Energy Commission
- ASME A112.18.3 (Back Flow)
- All applicable US Federal and State material regulations

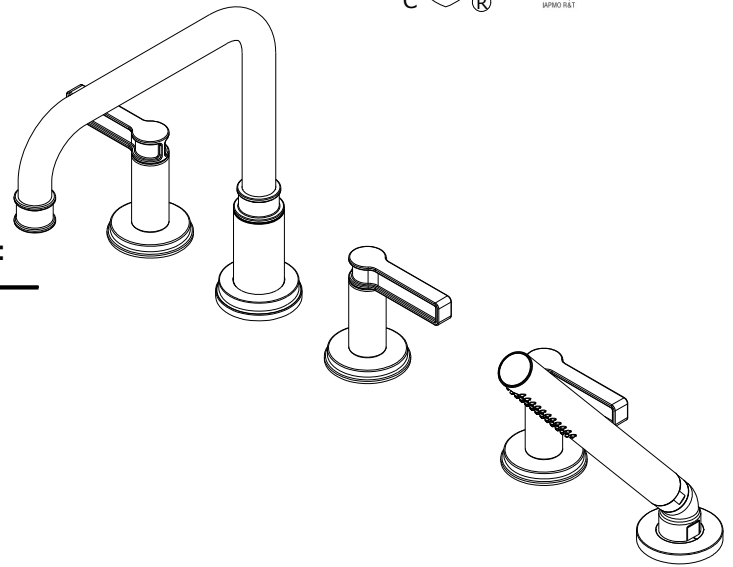

ACCESSORY REQUIRED	
System Element	Deck Tub Valve
Description	3-Valve Assembly With Quick Connect Spout Adapter
Inlet/Outlet Size	3/4" / 3/4"
Part Number	1-698
Image	

3-3277

PRODUCT DIMENSIONS *(Units are in inches)*

Product Dimensions are provided for reference only. For specific product installation guidelines, please reference the Installation Instructions of the product being installed.

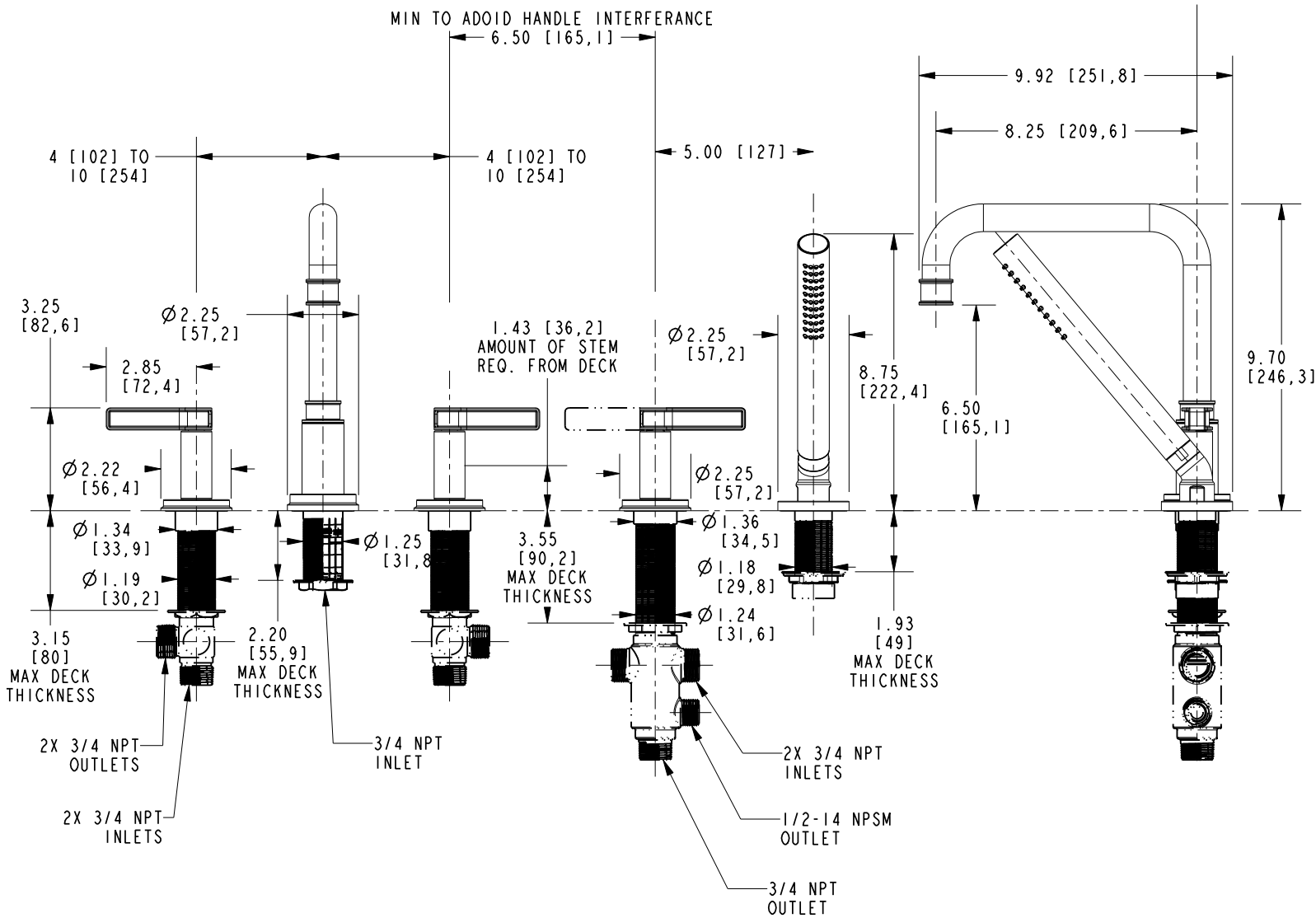

ROMAN TUB WITH HANDSHOWER DECK TRIM

3-3277

Page 2 of 2
EN-4697
REV C

NEWPORT BRASS
Flawless Beauty. From Faucet to Finish.

t: 949.417.5207 | www.newportbrass.com
©2025 NewportBrass