

EAST SQUARE

Features

BRIDGE STYLE KITCHEN FAUCET WITH SIDESPRAY

Solid brass construction
Bridge-style brass valve bodies
Quarter-turn washerless ceramic disc valve cartridges
Swivel spout assembly
Solid brass pull-out sidespray assembly
11.20" (28.4 cm) spout height at outlet
9.00" (22.8 cm) spout reach (c-c)
For 8.00" (20.3 cm) centers
ADA Compliant (Handles Only)
1.8 GPM (6.8 LPM) Max

1400-5412



Codes / Standards Compliance

Meets or exceeds the following at date of manufacture:

ASME A112.18.1/CSA B125.1-18
IAPMO/cUPC
NSF/ANSI/CAN 61, SECTION 9
NSF/ANSI 372
IPC
ADA & ICC/ANSI A117.1 (Handle Only)
Energy Policy Act of 1992
California Energy Commission
ASME A112.18.3 (Back Flow)
All applicable US Federal and State material regulations

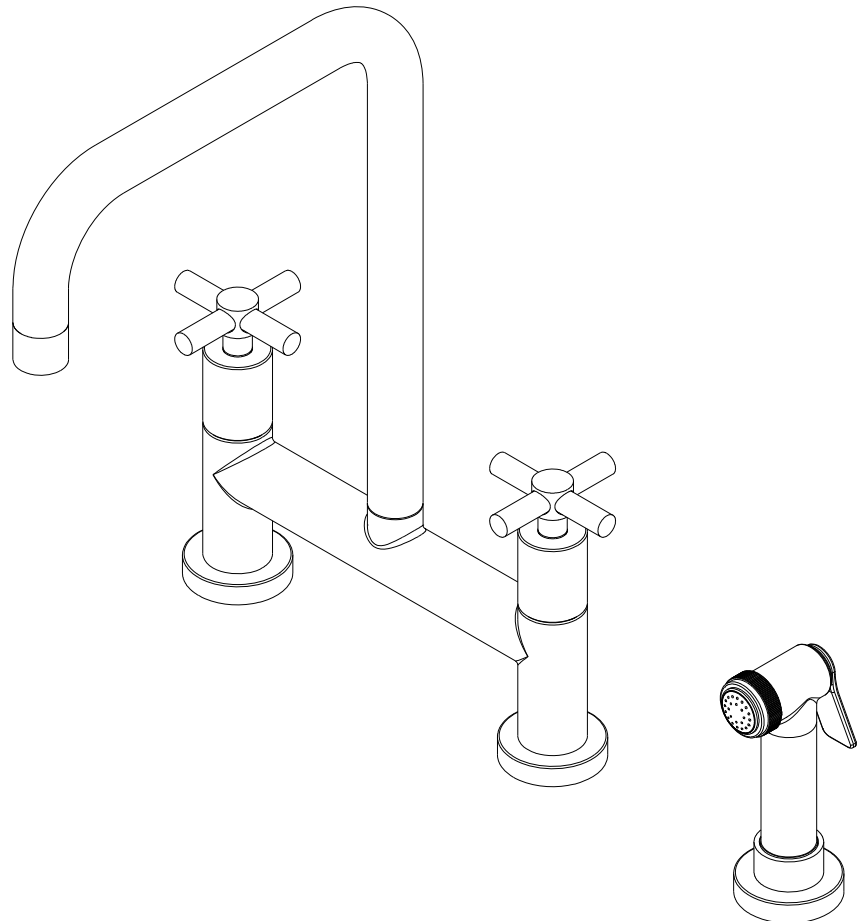

1400-5412

PRODUCT DIMENSIONS *(Units are in inches)*

Product Dimensions are provided for reference only. For specific product installation guidelines, please reference the Installation Instructions of the product being installed.

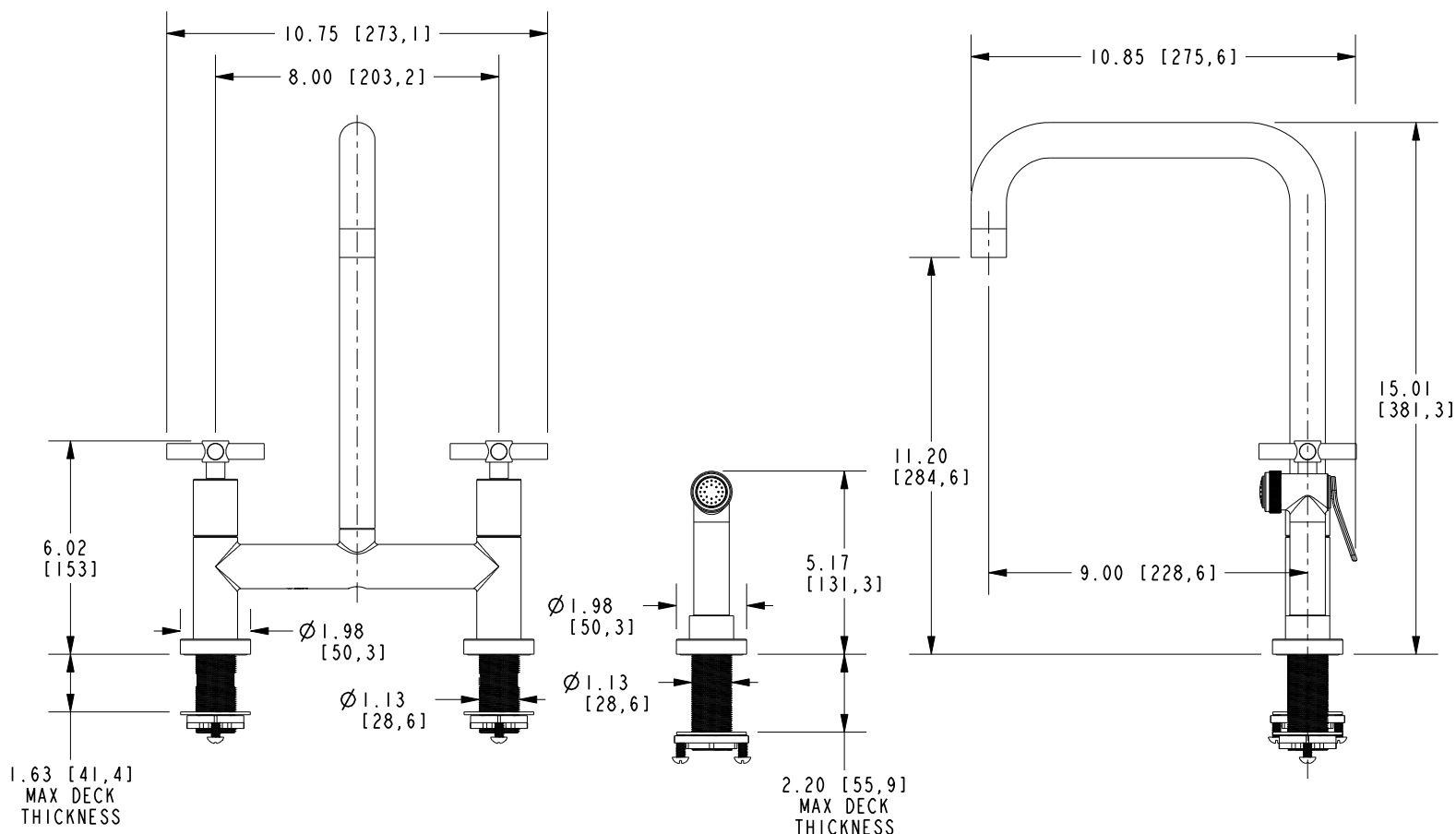

BRIDGE STYLE KITCHEN FAUCET WITH SIDESPRAY

1400-5412

Page 2 of 2
EN-4903-3
REV G

NEWPORT BRASS
Flawless Beauty. From Faucet to Finish.

t: 949.417.5207 | www.newportbrass.com
©2025 NewportBrass