

FLUSH-MOUNT BRACKET KIT MTK-618SS

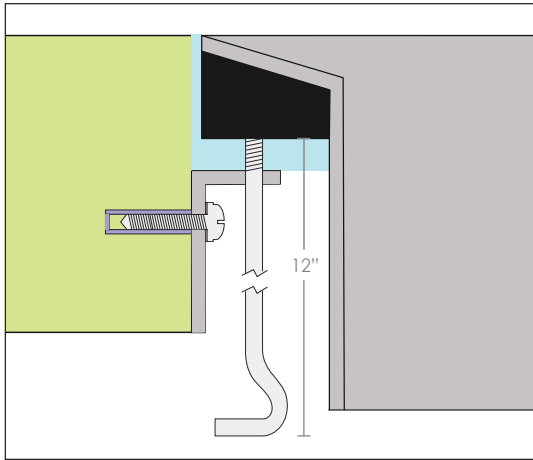

DESCRIPTION

Flush-mount Installation Kit

TECHNICAL INFORMATION

- 16 GA. 304 Stainless Steel Angle
- Stainless Steel 12" Height Adjusting Screw
- Stainless Steel Lock Washers
- Aluminum Anchors

INCLUDED PARTS

- #8-32 Screw
- 12" Height Adjusting Screw
- #8 Lock Washer
- #8-32 Standoff

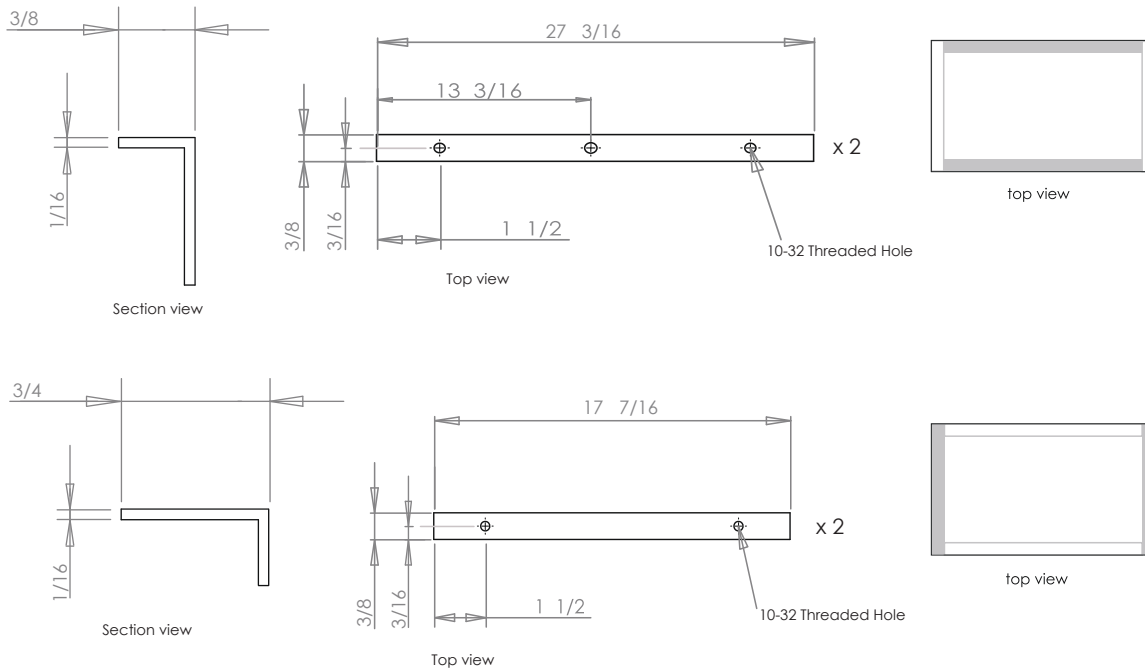
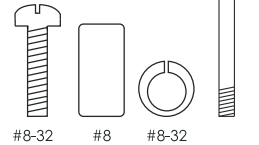

PROJECT INFORMATION			
Project			
Date	/ /	QTY	
Specifier			
Contact			
Note			